

SOLLEVATORI OLEOPNEUMATICI PORTATILI

AIR HYDRAULIC PORTABLE JACKS

215/P
217/P
221/P



Sollevatore Oleopneumatico per mezzi pesanti, leggero e maneggevole, con manico smontabile. Rientro automatico dei pistoni; le due valvole di discesa garantiscono una tenuta perfetta in ogni situazione e una velocità controllata sotto carico. La nostra serie portatile per "eccellenza", tutta l'efficacia e la praticità dei nostri sollevatori in una versione più compatta. Ideali da tenere a bordo del mezzo e per chi svolge assistenza su strada. Possono funzionare con i compressori di bordo dei mezzi.

Air hydraulic jacks for heavy vehicles, lightweight and easy to handle, with removable handle. The pistons move back automatically; the two descent valves guarantee perfect holding in all situations and controlled speed under load. Our portable series par "excellence", all the reliability and practicality of our jacks in a more compact version. Ideal for keeping on board the vehicle and for who provides road assistance. They can work with the vehicles' own compressors.



	YAK 215/P	YAK 217/P	YAK 221/P
Portata Capacity	40/20 t 44/22 ton	40/20 t 44/22 ton	40/20 t 44/22 ton
Peso netto Net weight	35 kg 77 lb	37 kg 82 lb	42 kg 93 lb
Pressione di alimentazione Working air pressure	8-10 bar 116-145 psi	8-10 bar 116-145 psi	8-10 bar 116-145 psi
Consumo d'aria Air waste	400 nl/min	400 nl/min	400 nl/min

ACCESSORI INCLUSI INCLUDED ACCESSORIES

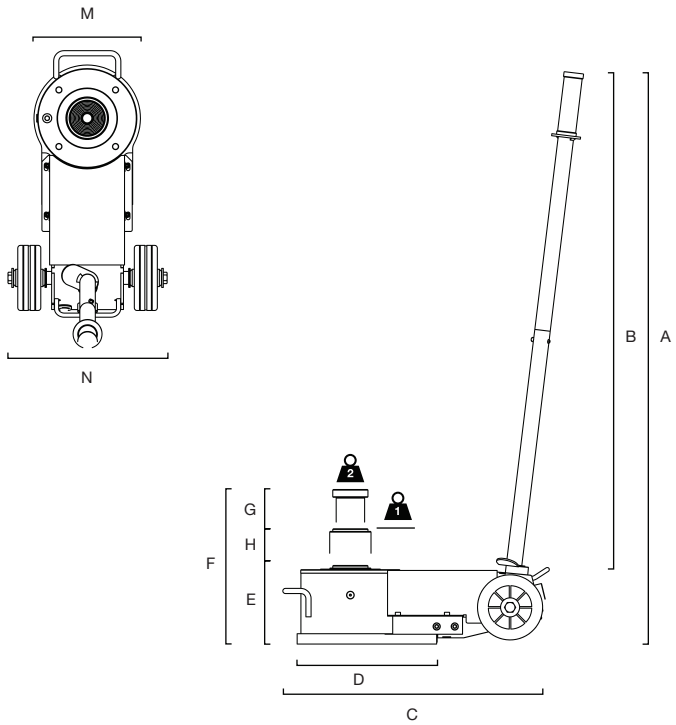









	YAK 215/P	YAK 217/P	YAK 221/P
A	1110 mm 43.70 in	1110 mm 43.70 in	1110 mm 43.70 in
B	960 mm 37.80 in	960 mm 37.80 in	960 mm 37.80 in
C	490 mm 19.29 in	490 mm 19.29 in	490 mm 19.29 in
D	325 mm 12.80 in	325 mm 12.80 in	325 mm 12.80 in
E	152 mm 5.98 in	174 mm 6.85 in	219 mm 8.62 in
F	299 mm 11.77 in	351 mm 13.81 in	469 mm 18.46 in
G	76 mm 2.99 in	88 mm 3.46 in	125 mm 4.92 in
H	71 mm 2.80 in	89 mm 3.50 in	125 mm 4.92 in
M	206 mm 8.11 in	206 mm 8.11 in	206 mm 8.11 in
N	310 mm 12.20 in	310 mm 12.20 in	310 mm 12.20 in

	20 t 22 ton	20 t 22 ton	20 t 22 ton
	40 t 44 ton	40 t 44 ton	40 t 44 ton



	YAK215/P	YAK217/P	YAK221/P
	•	•	•
	•	•	•
	•	•	•
	•	•	•
	•	•	•
	•	•	•
	•	•	•