

12 POINT IMPACT SOCKETS REGULAR LENGTH

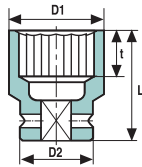

NOMINAL OPENING		CATALOG No.	D1	D2	L	t min	Weight
mm	A/F Inch		mm	mm	mm	mm	gr
19	3/4"	0812M19DH	28.7	30	38	9.5	130
20	13/16"	08M20DH	30.0	30	38	10.0	130
21		08M21DH	30.0	30	38	11.0	130
22		08M22DH	32.0	30	38	11.0	140
23	7/8"	0814DH	32.0	32	38	13.0	140
24		08M23DH	32.0	30	38	13.0	140
25	15/16"	0815DH	35.0	30	38	13.0	160
26		08M24DH	35.0	30	45	13.0	170
27	1"	08M25DH	39.0	30	45	13.0	170
28		0816DH	35.0	36	38	13.0	200
29	1 1/16"	08M26DH	38.0	30	50	13.0	200
30		0817M27DH	38.7	30	50	13.0	260
31	1 1/8"	08M28DH	40.0	30	50	14.0	260
32		0818DH	38.0	30	40	16.5	220
33	1 3/8"	08M29DH	40.0	30	50	16.5	290
34		0819M30DH	41.0	30	50	16.5	290
35	1 1/4"	08M31DH	43.0	30	50	16.5	290
36		0820DH	44.0	35	40	17.0	240
37	1 5/16"	08M32DH	44.0	30	50	17.0	300
38		08M33DH	45.0	30	50	17.0	300
39	1 3/8"	0821DH	45.0	35	43	19.0	260
40		08M34DH	49.0	35	46	19.0	300
41	1 7/16"	0822M35DH	48.5	38	50	19.0	300
42		08M36DH	49.0	35	50	19.0	300
43	1 1/2"	0823DH	49.0	38	50	19.0	300
44		08M37DH	52.0	44	47	19.0	400
45		0824M38DH	52.5	38	50	22.0	400



ONE PART INHEX DRIVER



NOMINAL OPENING		CATALOG No.	D2	L	H	Weight
mm	A/F Inch		mm	mm	mm	gr
01	1/8"	0802H	25	38	3	60
02	5/32"	08025H	25	38	4	60
03	3/16"	0803H	25	38	5	60
04	7/32"	08035H	25	38	6	60
05	1/4"	0804H	25	38	7	60
06	5/16"	0805H	25	38	8	65
07	3/8"	0806H	25	40	10	65
08	7/16"	0807H	25	40	11	65
09	1/2"	0808H	30	42	13	140
10	9/16"	0809H	30	43	14	140
11	5/8"	0810H	30	43	16	140
12		08M03H	25	38	3	60
13		08M04H	25	38	4	60
14		08M05H	25	38	5	65
15		08M06H	25	38	6	65
16		08M07H	25	38	7	65
17		08M08H	25	38	8	65
18		08M09H	25	38	9	65
19		08M10H	25	40	10	65
20		08M11H	25	40	11	140
21		08M12H	30	42	12	140
22		08M13H	30	42	13	140
23		08M14H	30	43	14	140
24		08M15H	30	43	15	140
25		08M16H	30	43	16	140
26		08M17H	30	45	17	140
27		08M18H	30	45	18	140
28		08M19H	30	50	19	140

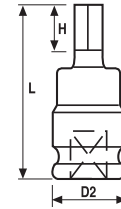

IMPACT SOCKETS FOR TORX® FASTNERS



NOMINAL OPENING TORX®		CATALOG No.	D1	D2	L	t min	Weight
mm	mm		mm	mm	mm	mm	gr
E10	08E10	15.0	25	38	9.0	85	
E11	08E11	15.5	25	38	9.0	85	
E12	08E12	16.0	25	38	10.0	91	
E14	08E14	18.5	25	38	12.0	91	
E16	08E16	20.0	25	38	12.0	95	
E18	08E18	22.0	25	38	12.0	95	
E20	08E20	25.0	30	38	13.0	140	
E22	08E22	26.5	30	45	15.0	158	
E24	08E24	28.5	30	45	17.0	161	

TORX® is a registered trademark of CAMCAR DIVISION OF TEXTRON

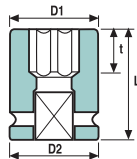

2 PARTS DRIVERS FOR TORX® SCREW



NOMINAL OPENING TORX®		CATALOG No.	D2	L	H	Weight
mm	mm		mm	mm	mm	gr
T30	08T30	25	57	3.19	110	
T40	08T40	25	57	3.30	110	
T45	08T45	25	57	3.81	110	
T50	08T50	25	57	4.57	110	
T55	08T55	25	57	5.08	110	
T60	08T60	30	60	7.62	160	
T70	08T70	30	60	8.89	170	

TORX® is a registered trademark of CAMCAR DIVISION OF TEXTRON

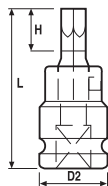

2 PARTS INHEX DRIVER



NOMINAL OPENING		CATALOG No.	D2	L	H	Weight
mm	A/F Inch		mm	mm	mm	gr
01	1/8"	0802V	25	54	6	90.0
02	5/32"	08025V	25	54	6	90.0
03	3/16"	0803V	25	54	8	90.0
04	7/32"	08035V	25	54	9	90.0
05	1/4"	0804V	25	54	12	100.0
06	5/16"	0805V	25	57	12	100.0
07	3/8"	0806V	25	57	16	100.0
08	7/16"	0807V	25	57	18	100.0
09	1/2"	0808V	30	57	19	150.0
10	9/16"	0809V	30	57	21	150.0
11	5/8"	0810V	30	59	24	150.0
12		08M03V	25	54	5	90.0
13		08M04V	25	54	6	90.0
14		08M05V	25	54	8	90.0
15		08M06V	25	54	9	100.0
16		08M07V	25	54	9	100.0
17		08M08V	25	57	12	100.0
18		08M09V	25	57	16	100.0
19		08M10V	25	57	16	100.0
20		08M11V	30	57	18	150.0
21		08M12V	30	57	18	150.0
22		08M13V	30	57	21	150.0
23		08M14V	30	57	21	150.0
24		08M15V	30	57	26	150.0
25		08M16V	30	59	26	150.0
26		08M17V	30	74	26	150.0
27		08M18V	30	74	26	150.0
28		08M19V	30	74	26	150.0

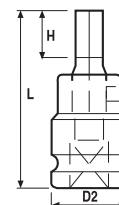

INHEX DRIVER 100mm long



NOMINAL OPENING		CATALOG No.	D2	L	H	Weight
mm	A/F Inch					
03		08M03HL4	25	100	3	90
04		08M04HL4	25	100	4	90
05		08M05HL4	25	100	5	90
06		08M06HL4	25	100	6	90
08		08M08HL4	25	100	8	90
10		08M10HL4	25	100	10	90
12		08M12HL4	30	100	12	200
14		08M14HL4	30	100	14	200
17		08M17HL4	30	100	17	200
19		08M19HL4	30	100	19	200
	1/8"	0802HL4	25	100	3	90
	5/32"	08025HL4	25	100	4	90
	3/16"	0803HL4	25	100	5	90
	7/32"	08035HL4	25	100	6	90
	1/4"	0804HL4	25	100	7	90
	5/16"	0805HL4	25	100	8	90
	3/8"	0806HL4	25	100	10	90
	7/16"	0807HL4	25	100	11	90
	1/2"	0808HL4	30	100	13	200
	9/16"	0809HL4	30	100	14	200
	5/8"	0810HL4	30	100	16	200

INHEX DRIVER 150mm long



NOMINAL OPENING		CATALOG No.	D2	L	H	Weight
mm	A/F Inch					
03		08M03HL6	25	150	3	120
04		08M04HL6	25	150	4	120
05		08M05HL6	25	150	5	120
06		08M06HL6	25	150	6	120
08		08M08HL6	25	150	8	120
10		08M10HL6	25	150	10	120
12		08M12HL6	30	150	12	230
14		08M14HL6	30	150	14	230
17		08M17HL6	30	150	17	230
19		08M19HL6	30	150	19	230
	1/8"	0802HL6	25	150	3	120
	5/32"	08025HL6	25	150	4	120
	3/16"	0803HL6	25	150	5	120
	7/32"	08035HL6	25	150	6	120
	1/4"	0804HL6	25	150	7	120
	5/16"	0805HL6	25	150	8	120
	3/8"	0806HL6	25	150	10	120
	7/16"	0807HL6	25	150	11	120
	1/2"	0808HL6	30	150	13	230
	9/16"	0809HL6	30	150	14	230
	5/8"	0810HL6	30	150	16	230

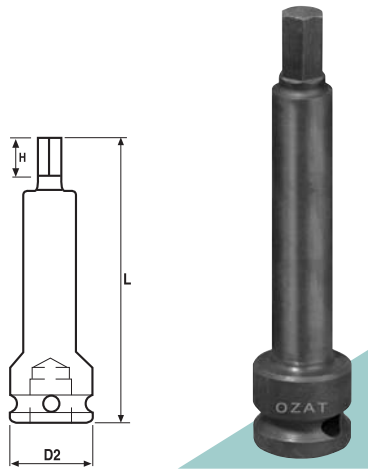

ORANGE MAGNETIC SOCKETS

6 POINT IMPACT SOCKETS REGULAR LENGTH



NOMINAL OPENING			D1	D2	L	t min	Weight
mm	A/F Inch	CATALOG No.					
	3/8"	0806M	16.0	25	38	4.0	80
10		08M10M	17.0	25	38	5.0	90
11		08M11M	19.0	25	38	5.0	80
	7/16"	0807M	19.0	25	38	6.0	80
12		08M12M	20.0	25	38	6.0	90
	1/2"	0808M	20.0	25	38	6.0	90
13		08M13M	21.0	25	38	6.0	90
14		08M14M	22.5	25	38	7.0	90
	9/16"	0809M	22.0	25	38	7.0	90
15		08M15M	23.7	30	38	7.0	130
	5/8"	0810M	25.0	25	38	8.0	90
16		08M16M	25.0	30	38	8.0	130
17		08M17M	26.0	30	38	9.0	130
	11/16"	0811M	26.0	26	38	9.0	90
18		08M18M	27.5	30	38	9.0	130
19	3/4"	0812M19M	28.7	30	38	9.5	130

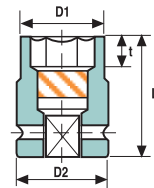

6 POINT IMPACT SOCKETS LONG

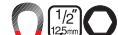

NOMINAL OPENING			D1	D2	L	t min	Weight
mm	A/F Inch	CATALOG No.					
	3/8"	0806LM	16.0	25	78	4.0	140
10		08M10LM	17.0	25	78	5.0	160
11		08M11LM	19.0	25	78	5.0	160
	7/16"	0807LM	19.0	25	78	6.0	140
12		08M12LM	20.0	25	78	6.0	160
	1/2"	0808LM	20.0	25	78	6.0	140
13		08M13LM	21.0	25	78	6.0	160
14		08M14LM	22.5	25	78	7.0	160
	9/16"	0809LM	22.0	25	78	7.0	160
15		08M15LM	23.7	30	78	7.0	240
	5/8"	0810LM	25.0	25	78	8.0	200
16		08M16LM	25.0	30	78	8.0	240
17		08M17LM	26.0	30	78	9.0	240
	11/16"	0811LM	26.0	26	78	9.0	190
18		08M18LM	27.5	30	78	9.0	250
19	3/4"	0812M19LM	28.7	30	78	9.5	250

