

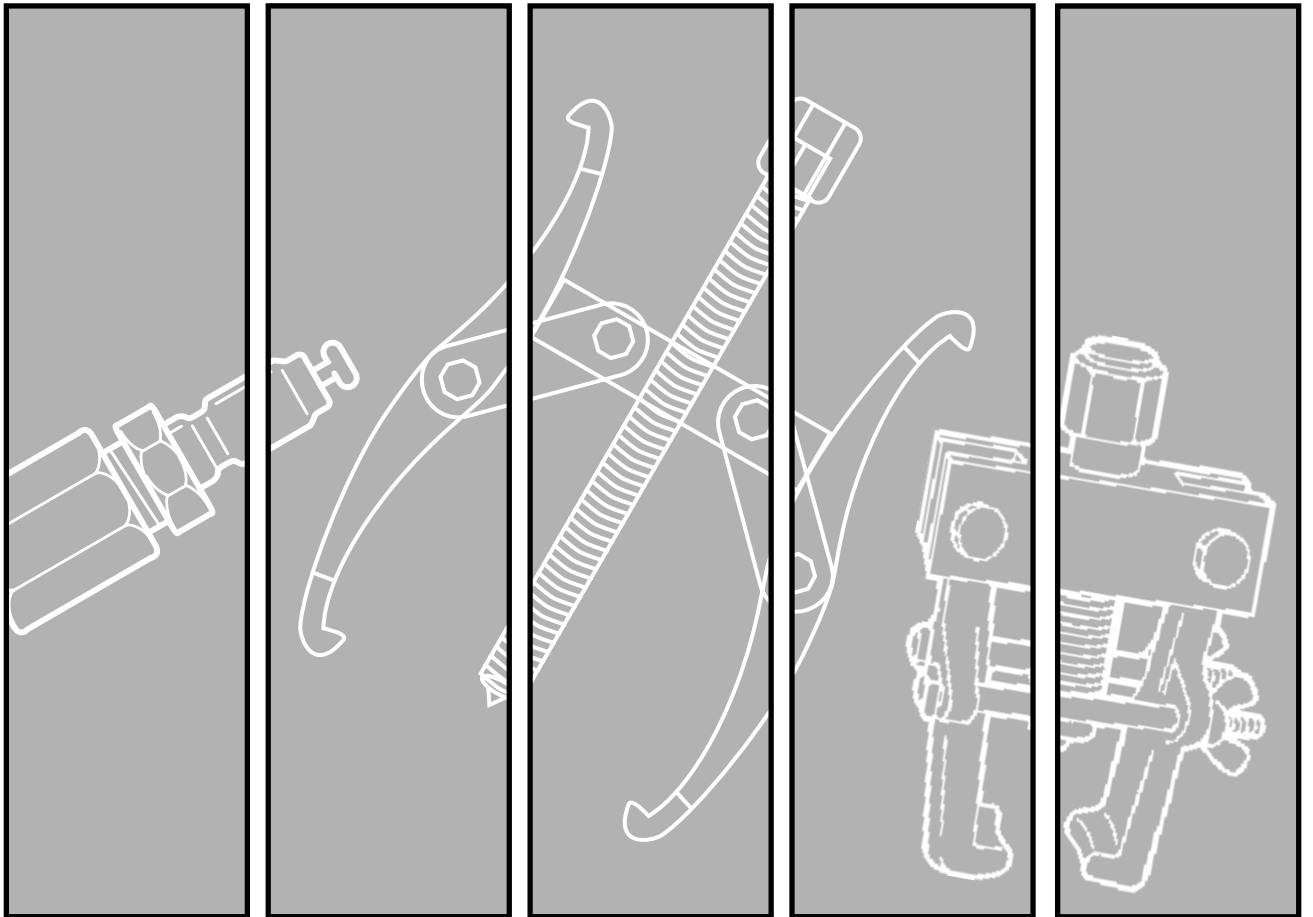

# MECHANICAL PARTS CATALOG



Catalog No. PC-2005  
Supersedes PC-98  
\$4.95



## **LIFETIME MARATHON WARRANTY®**

Effective 4-1-84; Rev. 5-15-2000

**THIS WARRANTY IS EXPRESSLY LIMITED TO ORIGINAL RETAIL BUYERS OF SPX's OTC BRAND PRODUCTS OR PARTS ("OTC PRODUCTS"). THIS WARRANTY IS NOT ASSIGNABLE OR TRANSFERABLE. SPX MAKES NO WARRANTY TO ANYONE ELSE, INCLUDING OTHER PURCHASERS AND/OR USERS, AND NONE SHALL BE IMPLIED.**

Except as otherwise provided in this warranty, OTC Products are warranted against defects in materials and workmanship for the life of the OTC Product, meaning that point in time when the OTC Product no longer functions due to normal wear. This warranty does not apply to electronic products, which are covered by separate warranties. Nor does this warranty apply to the following items, which may be incorporated into or sold with OTC Products and which are sold "as-is" with all faults: chains, batteries, electric motors, knives, and cutter blades. (Electric motors are warranted by their manufacturers under conditions stated in their warranties.)

The sole and exclusive remedy for any OTC Product found to be defective is repair or replacement, at the option of SPX. If this exclusive remedy is deemed to have failed of its essential purpose, SPX's liability shall not exceed the purchase price of the OTC Product. In no event will SPX be liable for any direct, indirect, special, incidental, or consequential damages (including lost profit) whether based on warranty, contract, tort, or any other legal theory.

This warranty does not cover any OTC Product that has been abused, altered, worn out, contaminated, rusted, heated, ground, damaged due to side loading, used for a purpose other than that for which it was intended, or used in a manner inconsistent with SPX/OTC's instructions regarding use. The existence of a defect shall be determined by SPX in accordance with procedures established by SPX. No one is authorized to make any statement or representation altering the terms of this warranty.

**THIS WARRANTY IS IN LIEU OF ANY OTHER WARRANTY, EXPRESS OR IMPLIED, INCLUDING ANY WARRANTY OF MERCHANTABILITY OR FITNESS FOR A PARTICULAR PURPOSE.**

### **SOFTWARE**

The above warranty applies to OTC Product software except that, instead of warranting against defects in materials and workmanship, SPX warrants that OTC Product software, when correctly installed, will execute its programmed instructions. SPX does not warrant that software will operate uninterrupted or error-free. OTC Product software is proprietary, confidential information protected under copyright law. Users have no right in or title to OTC Product software other than a limited right of use revocable by SPX. OTC Product software may not be transferred or disclosed without the written consent of SPX and may not be copied except in ordinary backup procedures.

### **REPAIR**

Should your OTC Product require repair service, return it freight prepaid to an OTC authorized service center, and provide proof of purchase. If the OTC Product is covered by warranty, SPX will return the repaired OTC Product, or a replacement, ground freight prepaid. If the OTC Product is determined to be out of warranty, it will be repaired for a reasonable charge plus return freight.





**FOR PRICE INFORMATION  
SEE OTC's MASTER PRICE LIST**

Tool No.	Page	Tool No.	Page	Tool No.	Page	Tool No.	Page
Old/New Part Nos. Cross Ref. .... 61-62							

§ Discontinued. Some service parts may be available.

FOR PRICE INFORMATION  
SEE OTC's MASTER PRICE LIST

**No. 518**  
Flange-type Puller

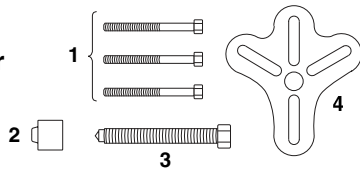

Item No.	Service Part No.	Description
1	10059	Hex Hd. Cap Screw, 3/8-24 x 3" (3 reqd.)
1	10060	Hex Hd. Cap Screw, 3/8-16 x 3" (3 reqd.)
2	26342	Special Plug (shaft protector)
3	24833	Forcing Screw
4	512888	Puller Flange

**No. 522**  
Gear & Pulley Puller

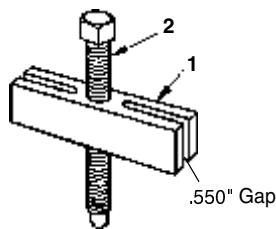

Item No.	Service Part No.	Description
1	22186	Cross Block, 8.25" Long
2	34703	Forcing Screw, 3/4-16 x 11.4"

**No. 525**  
Flange-type  
Puller Combination

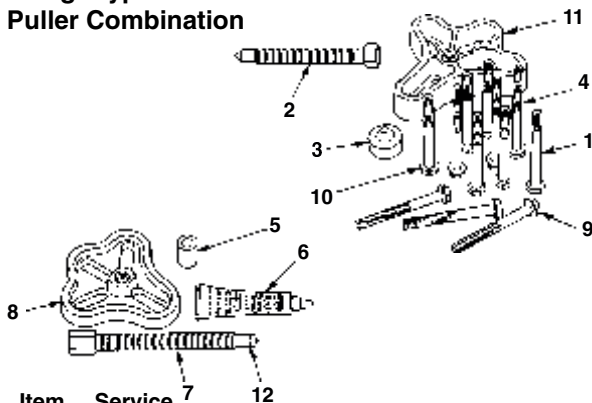

Item No.	Service Part No.	Description
1	10059	Hex Head Cap Screw, 3/8-24 x 3"
2	24833	Forcing Screw, 5/8-18 x 5"
3	26342	Special Plug (shaft protector)
4	209950	Flange Head Cap Screw, 3/8-16 x 3 1/2"
5	209802	Collar
6	39448	Oil
7	304828	Forcing Screw, 7/16-20 x 5"
8	208170	Flange
9	209951	Flange Head Cap Screw, 5/16-18 x 3 1/2"
10	209952	Flange Head Cap Screw, 5/16-24 x 3 1/2"
11	32843	Puller Flange
12	209803	O-ring

**No. 679**  
V-Belt Pulley Pulling Attachment

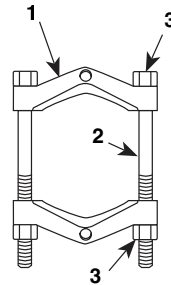

Item No.	Service Part No.	Description
1	26763	Block
2	26762	Stud, 1/2-20 x 7 1/2"
3	10210	Hex Nut (4 reqd.)

**No. 680**  
Pulley Pulling Attachment

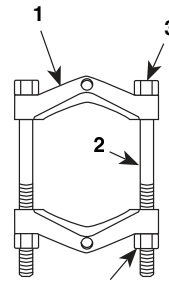

Item No.	Service Part No.	Description
1	31385	Block
2	24828	Stud, 3/4-16 x 14"
3	10215	Hex Nut (4 reqd.)

**No. 898A**  
Body & Fender Dent Puller

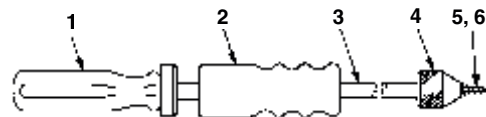

Item No.	Service Part No.	Description
1	N4000	Plastic Handle
2	21949	Hammer
3	21951	Shank
4	21953	Retainer
5	10241	Lock Washer
6	11200	Screw

**No. 927**  
10-Ton Push Puller

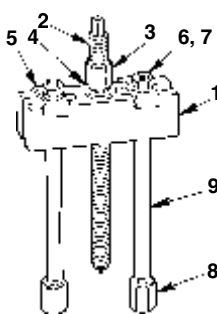

Item No.	Service Part No.	Description
1	33483	Cross Block
2	24835	Forcing Screw
3	24836	Forcing Screw Nut
4	24837	Forcing Screw Washer
5	24838	Sliding Plate
6	24839	Leg Washer
7	10210	Leg Hex Nut
8	24827	Leg End
9	1100	6 <sup>3</sup> / <sub>4</sub> " Legs (pr.)
-	24840	6 <sup>3</sup> / <sub>4</sub> " Leg (1 only)
-	1101	15 <sup>3</sup> / <sub>4</sub> " Legs (pr.)
-	25934	15 <sup>3</sup> / <sub>4</sub> " Leg (1 only)
-	1102	11 <sup>3</sup> / <sub>4</sub> " Legs (pr.)
-	25935	11 <sup>3</sup> / <sub>4</sub> " Leg (1 only)
-	1103	4 <sup>3</sup> / <sub>4</sub> " Legs (pr.)
-	25936	4 <sup>3</sup> / <sub>4</sub> " Leg (1 only)
-	104819	Instruction Sheet

**No. 939**  
30-Ton Push Puller

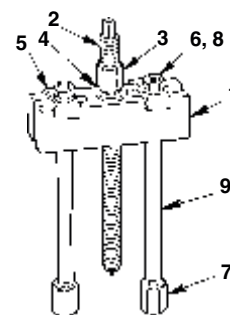

Item No.	Service Part No.	Description
1	33038	Cross Block
2	303961	Forcing Screw
3	208586	Forcing Nut
4	208587	Thrust Washer
5	28353	Sliding Plate
6	24824	Leg Washer
7	28390	Leg End
8	10220	Leg Nut
9	1109	8" Legs (pr.)
-	32992	8" Leg (1 only)
-	1110	18" Legs (pr.)
-	32991	18" Leg (1 only)
-	1111	28" Legs (pr.)
-	32998	28" Leg (1 only)
-	104819	Instruction Sheet

**No. 938**  
17<sup>1</sup>/<sub>2</sub>-Ton Push Puller

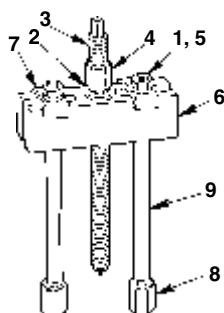

Item No.	Service Part No.	Description
1	24826	Leg Washer
2	24824	Thrust Washer
3	24822	Forcing Screw
4	19528	Forcing Screw Hex Nut
5	10215	Hex Nut
6	32127	Block
7	24825	Sliding Plate
8	24827	Leg Cap
-	1104	16 <sup>1</sup> / <sub>2</sub> " Legs (pr.)
-	32135	16 <sup>1</sup> / <sub>2</sub> " Leg (1 only)
-	1105	22 <sup>1</sup> / <sub>2</sub> " Legs (pr.)
-	32964	22 <sup>1</sup> / <sub>2</sub> " Leg (1 only)
9	1106	9 <sup>1</sup> / <sub>2</sub> " Legs (pr.)
-	32126	9 <sup>1</sup> / <sub>2</sub> " Leg (1 only)
-	1107	4 <sup>1</sup> / <sub>2</sub> " Legs (pr.)
-	32132	4 <sup>1</sup> / <sub>2</sub> " Leg (1 only)
-	1108	30" Legs (pr.)
-	32968	30" Leg (1 only)
-	104819	Instruction Sheet

**No. 981**  
Blind Hole Puller Set

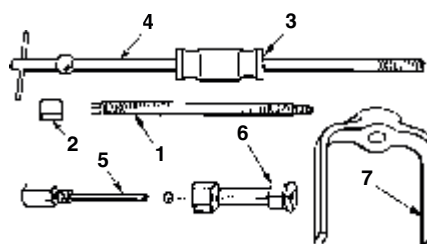

Item No.	Service Part No.	Description
1	24835	Forcing Screw
2	24836	Forcing Screw Nut
3	22185	2 <sup>1</sup> / <sub>2</sub> Lb. Hammer
4	208627	Shank and Tee Bar Assembly
5	28250	Actuator Pin, 1/8" Dia.
5	28253	Actuator Pin, 3/16" Dia.
5	28256	Actuator Pin, 1/2" Dia.
6	33856	Collet, 5/16"
6	33857	Collet, 3/8"
6	33858	Collet, 7/16"
6	33859	Collet, 1/2"
6	33860	Collet, 5/8"
6	33861	Collet, 3/4"
6	33862	Collet, 7/8"
6	33863	Collet, 1-1/4"
6	33864	Collet, 1 1/4-1 1/2"
6	33865	Collet, 1 1/2-1 3/4"
7	41331	Bridge
-	28323-GY8	Metal Storage Box
-	104994	Parts List

FOR PRICE INFORMATION  
SEE OTC's MASTER PRICE LIST

**No. 1020  
1021**  
1-Ton Grip-O-Matic  
Puller

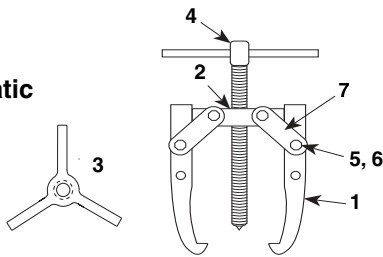

Item No.	Service Part No.	Description
1	21908	Jaw, 2 <sup>11</sup> / <sub>16</sub> " (1 only)
2	27592	2-Way Head (1020)
3	27475	3-Way Head (1021)
4	207029	Forcing Screw
5	21917	Hex Head Cap Screw
6	10197	Steel Hex Nut
7	27764	Strap

**No. 1022  
1023**  
2-Ton Grip-O-Matic  
Puller

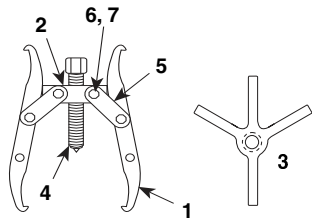

Item No.	Service Part No.	Description
1	43661	Jaw, 4 <sup>1</sup> / <sub>16</sub> " (1 only)
2	27476	2-Way Head (1022)
3	33423	2/3-Way Head (1023)
4	22006	Forcing Screw, 3/8-24 x 4 <sup>7</sup> / <sub>8</sub> "
5	22007	Strap
6	22008	Hex Head Cap Screw
7	10382	Hex Jam Nut

**No. 1035  
1036  
1037  
1038**  
7-Ton Grip-O-Matic Puller

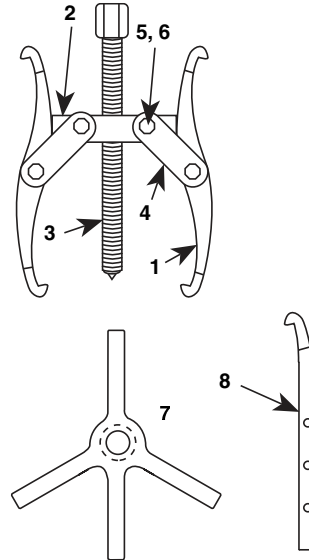

Item No.	Service Part No.	Description
1	44082	8 <sup>1</sup> / <sub>2</sub> " Reversible Jaw for 1035, 1037
2	27759	Forged Head for 1035, 1036
3	33398	Forcing Screw, 1 <sup>1</sup> / <sub>16</sub> -18 x 9"
4	22018	Strap
5	22016	Hex Head Cap Screw
6	10386	Hex Jam Nut
7	44993	2/3-Way Head for 1037, 1038
8	43892	10 <sup>1</sup> / <sub>4</sub> " Long Jaw for 1036, 1038

**No. 1024  
1025  
1026  
1027**  
5-Ton Grip-O-Matic  
Puller

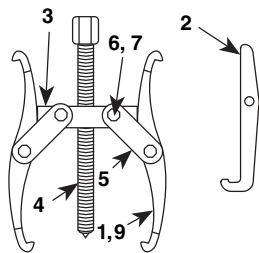

**No. 1028  
1031**  
Differential Bearing  
Puller

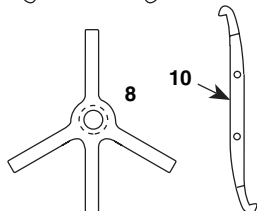

Item No.	Service Part No.	Description
1	44591	Reversible Jaw for 1024, 1026, 4 <sup>7</sup> / <sub>8</sub> " (1 only)
2	22023	Carrier Bearing Jaw for 1028, 4 <sup>7</sup> / <sub>8</sub> "
3	39959	Forged Head for 1024, 1025, 1028, 1031
4	33397	Forcing Screw, 9/16-20 x 6 <sup>3</sup> / <sub>4</sub> "
5	22025	Strap
6	22021	Hex Head Cap Screw
7	10384	Hex Jam Nut
8	39942	2/3-Way Head for 1026, 1027
9	26481	Carrier Bearing Jaw for 1031, 4 <sup>7</sup> / <sub>8</sub> " (1 only)
10	43940	Reversible Jaw for 1025, 1027, 6 <sup>1</sup> / <sub>2</sub> " (1 only)



FOR PRICE INFORMATION  
SEE OTC's MASTER PRICE LIST

**No. 1039**  
**1040**  
**1041**  
**1042**  
13-Ton Grip-O-Matic  
Puller

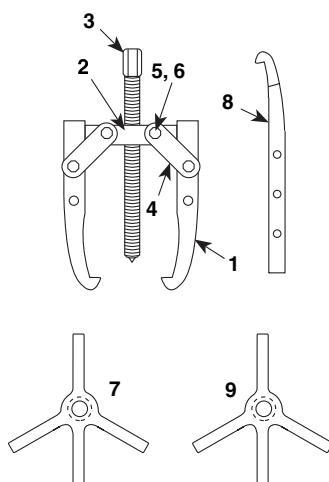

Item No.	Service Part No.	Description
1	43906	13" Jaw for 1039, 1041
2	33295	Forged Head for 1039, 1040
3	33399	Forcing Screw, $1\frac{3}{16}$ -16 x $12\frac{1}{2}$ "
4	22028	Strap
5	10388	Hex Jam Nut
6	22029	Hex Head Cap Screw
7	41195	2/3-Way Head for 1041, 1042
8	30902	Jaw, $17\frac{1}{8}$ " Long for 1040, 1042, 1060, 1061
9	41563	2/3-Way Head for 1060, 1061
-	34602	Pusher Adapter for 1060, 1061
-	4105	10-Ton Ram for 1061

**No. 1060 §**  
**1061 §**  
10-Ton Grip-O-Matic  
Puller

Note: 1061 is 1060 with a 4105.

**No. 1043**  
**1044**  
**1045**  
**1046**  
**1064**  
**1065**  
**1066**  
**1067**  
17½-Ton Grip-O-Matic  
Puller

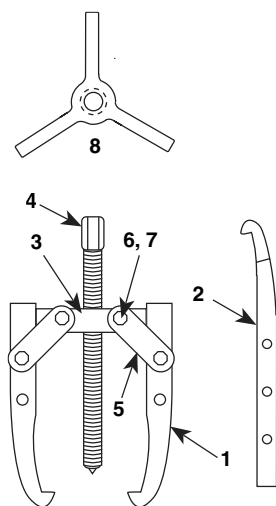

Item No.	Service Part No.	Description
1	30945	17¾" Jaw for 1043, 1045
2	30949	21½" Long Jaw for 1044, 1046, 1064, 1066
3	33292	Forged Head for 1043, 1044
4	33290	Forcing Screw, 1-14 x $13\frac{3}{4}$ "
5	22034	Strap
6	22035	Hex Head Cap Screw
7	10392	Hex Jam Nut
8	41196	3-Way Head for 1045, 1046
-	41224	2-Way Head for 1064
-	41254	Hydraulic 3-Way Head for 1066

Note: 1065 consists of 1064 Puller, 24814 Adjusting Crank, 32118 Ram Adjusting Screw, 4120 17½-Ton Ram.  
1067 consists of 1066 Puller, 24814 Adjusting Crank, 32118 Ram Adjusting Screw, 4120 17½-Ton Ram.

**No. 1047**  
**1048**  
**1049**  
**1050**  
25-Ton Grip-O-Matic  
Puller

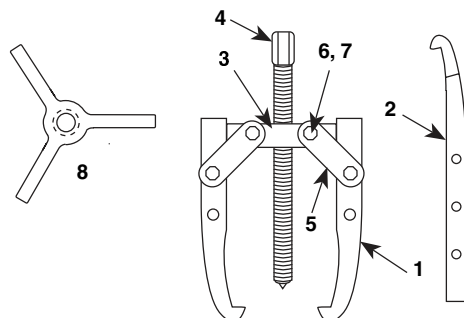

Item No.	Service Part No.	Description
1	40303	18¾" Jaw for 1047, 1049
2	40305	25¼" Long Jaw for 1048, 1050
3	33433	Forged Head for 1047, 1048
4	33432	Forcing Screw, $1\frac{1}{4}$ -12 x $15\frac{15}{16}$ "
5	30966	Strap
6	22045	Hex Head Cap Screw
7	10394	Hex Jam Nut
8	41198	3-Way Head for 1049, 1050

FOR PRICE INFORMATION  
SEE OTC's MASTER PRICE LIST

**No. 1057 §  
1058 §**  
**5-Ton Hydraulic  
Grip-O-Matic Puller**

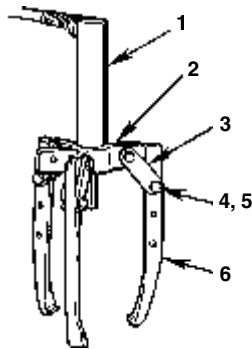

Item No.	Service Part No.	Description
1	420004	5-ton Ram Assembly for 1058
2	47997	2/3-Way Head
3	22018	Strap
4	22016	Hex Head Cap Screw
5	10386	Hex Jam Nut
6	43892	Long Jaw
-	309874	Pushing Adapter for 1058
-	309875	Pushing Adapter for 1058

**No. 1062  
1063**  
**17 1/2-Ton Hydraulic  
Push-Puller**

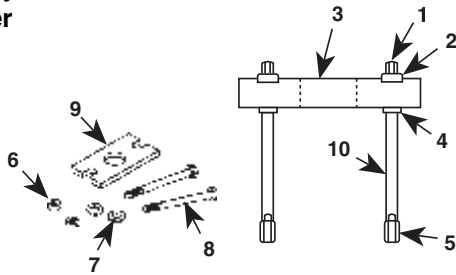

Item No.	Service Part No.	Description
1	10215	Hex Nut
2	24825	Sliding Plate
3	32127	Cross Block
4	24826	Leg Washer

5	24827	Leg Cap
6	10201	5/16-18 Hex Nut
7	10257	Washer for 5/16" Bolt
8	214480	Cap Screw, 5/16-18 x 3 3/4"
9	308244	Plate
10	1104	16 1/2" Legs (pr.)
-	32135	16 1/2" Leg (1 only)
-	1105	22 1/2" Legs (pr.)
-	32964	22 1/2" Leg (1 only)
-	1106	9 1/2" Legs (pr.)
-	32126	9 1/2" Leg (1 only)
-	1107	4 1/2" Legs (pr.)
-	32132	4 1/2" Leg (1 only)
-	1108	30" Legs (pr.)
-	32968	30" Leg (1 only)

**Note:** 1063 consists of 1062 Push-Puller, 24814 Adjusting Crank, 32118 Ram Adjusting Screw, 4120 17 1/2-Ton Ram.

**No. 1070  
1071**  
**30-Ton Hydraulic  
Push-Puller**

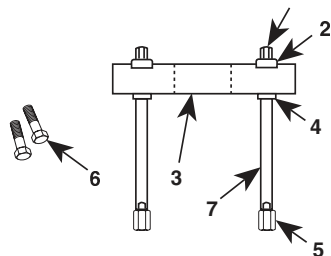

1	10220	Hex Nut
2	28353	Sliding Plate
3	33039	Cross Block
4	24824	Leg Washer
5	28390	Leg Cap
6	10070	Cap Screw, 7/16-20 x 2"
7	1110	18" Legs (pr.)
-	32991	18" Leg (1 only)
-	1111	28" Legs (pr.)
-	32998	28" Leg (1 only)
-	1109	8" Legs (pr.)
-	32992	8" Leg (1 only)

**Note:** 1071 consists of 1070 Push-Puller, 27198 Adjusting Crank, 34758 Ram Adjusting Screw, 4121 30-Ton Power Twin Ram and Coupler.

**No. 1072**  
**1073**  
**1074**  
**1075**

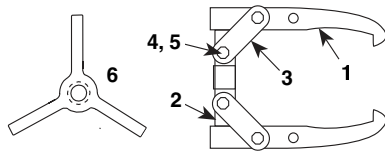

**30-Ton Hydraulic Grip-O-Matic Puller**

Item No.	Service Part No.	Description
1	40312	Jaw, 30 <sup>3</sup> / <sub>4</sub> " Long
2	41226	2-Way Head for 1072
3	30976	Strap
4	22052	Cap Screw
5	22053	Hex Nut
6	50462	3-Way Head for 1074

**Note:** 1073 consists of 1072 puller, 27198 Adjusting Crank, 34758 Ram Adjusting Screw, 4121 30-Ton Power Twin Ram and Coupler.

1075 consists of 1074 puller, 27198 Adjusting Crank, 34758 Ram Adjusting Screw, 4121 30-Ton Power Twin Ram and Coupler.

**No. 1121**  
**Bearing Splitter**

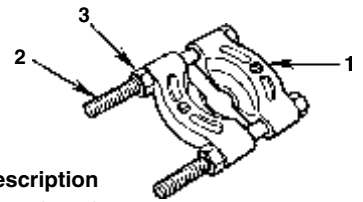

Item No.	Service Part No.	Description
1	26654	Block (each)
2	10042	Cap Screw, <sup>5</sup> / <sub>16</sub> -24 x 3"
3	10203	Hex Nut

**No. 1122**  
**Bearing Splitter**

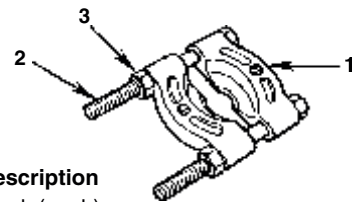

Item No.	Service Part No.	Description
1	26651	Block (each)
2	24831	Cap Screw, <sup>7</sup> / <sub>16</sub> -20 x 4 <sup>1</sup> / <sub>2</sub> "
3	10207	Hex Nut

**No. 1076**  
**1077 §**

**50-Ton Hydraulic Push Puller**

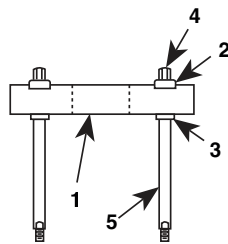

Item No.	Service Part No.	Description
1	50503	Cross Block
2	33785	Upper Sliding Plate
3	28163	Leg Washer
4	10224	1 <sup>1</sup> / <sub>4</sub> " N.F. Hex Nut
5	1112	24" Legs (pr.)
-	33004	24" Leg (1 only)
-	1113	34" Legs (pr.)
-	33005	34" Leg (1 only)

**Note:** 1077 includes 29595 Adjusting Crank, 32698 Ram Adjusting Screw, 4122 50-Ton Ram.

**No. 1123**  
**Bearing Splitter**

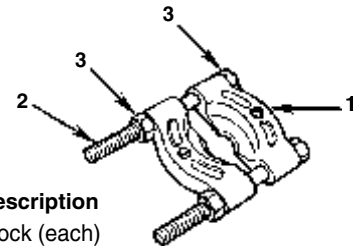

Item No.	Service Part No.	Description
1	32957	Block (each)
2	23333	Stud, <sup>5</sup> / <sub>8</sub> -18 x 8 <sup>1</sup> / <sub>2</sub> "
3	10213	Hex Nut (4 reqd.)

**No. 1124**  
**Bearing Splitter**

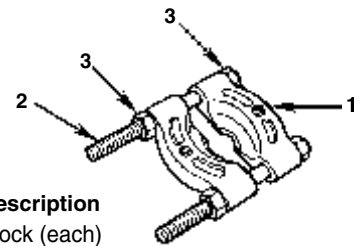

Item No.	Service Part No.	Description
1	32951	Block (each)
2	24829	9 <sup>1</sup> / <sub>2</sub> " Stud, <sup>3</sup> / <sub>4</sub> -16 x 10 <sup>7</sup> / <sub>8</sub> "
3	10215	Hex Nut (4 reqd.)

**No. 1080**  
**50-Ton Hydraulic Grip-O-Matic Puller**

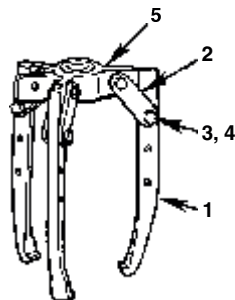

Item No.	Service Part No.	Description
1	30994	Jaw, 43" Long
2	30993	Strap
3	22089	Hex Head Cap Screw
4	10220	Hex Nut
5	50460	3-Way Head

**No. 1126**  
**Bearing Splitter**

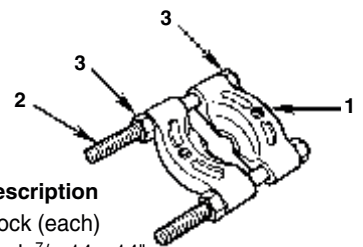

Item No.	Service Part No.	Description
1	33486	Block (each)
2	26639	Stud, <sup>7</sup> / <sub>8</sub> -14 x 14"
3	10218	Hex Nut (4 reqd.)

FOR PRICE INFORMATION  
SEE OTC's MASTER PRICE LIST

**No. 1127**  
Bearing Splitter

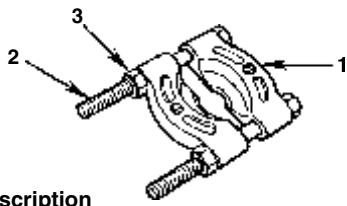

Item No.	Service Part No.	Description
1	32959	Block (each)
2	23757	Bolt, 1 1/8-12 x 20" Long
3	214550	Hex Nut (4 reqd.)

**No. 1128**  
Bearing Splitter

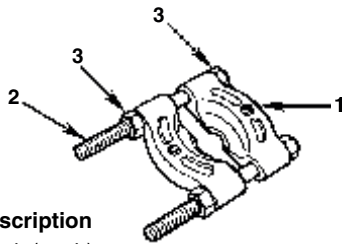

Item No.	Service Part No.	Description
1	50855	Block (each)
2	26640	Stud, 1 1/2-12 x 21"
3	10226	1 1/2" N.F. Hex Nut (4 reqd.)
-	30944	Pulling Tee

**No. 1129**  
Bearing Splitter

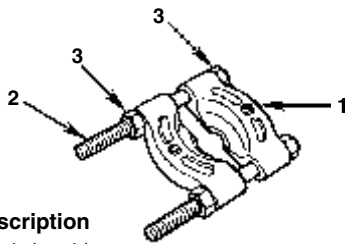

Item No.	Service Part No.	Description
1	32961	Block (each)
2	23329	Stud, 1 3/4-12 x 27 1/2"
3	23330	1 3/4" N.F. Hex Nut (4 reqd.)
-	31037	Pulling Tee

**No. 1130**  
Bearing Splitter

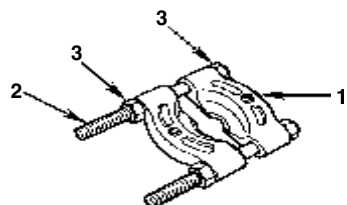

Item No.	Service Part No.	Description
1	32951	Block (each)
2	24828	13" Stud, 3/4-16 x 14 1/8"
3	10215	Hex Nut (4 reqd.)

**No. 1150**  
**1151**  
**1152**  
**1153**  
**1154**  
Internal Pulling  
Attachment

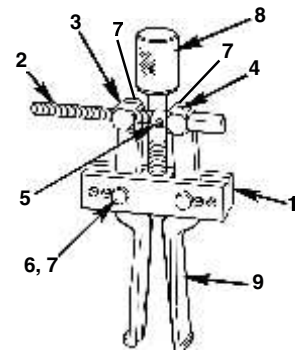

Item No.	Service Part No.	Description
1	33482	Slotted Block
2	24846	Adjusting Screw
3	24847	Tapped Swivel
4	24848	Plain Swivel
5	11560	Roll Pin
6	10054	Hex Head Cap Screw
7	10386	Hex Jam Nut
8	24850	1"-14 Reducing Adapter for 1150, 1151, 1153
8	24864	1"-8 Swivel Adapter for 1154
9	32136	Jaw, 5 1/2" Reach (1 only) for 1151
9	32137	Jaw, 4" Reach (1 only) for 1150, 1152, 1154
9	32139	Jaw, 2 1/4" Reach (1 only) for 1153

**No. 1155**  
Slide Hammer Unit

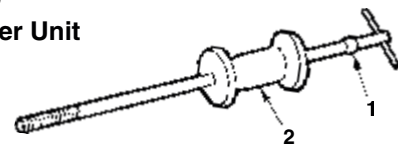

Item No.	Service Part No.	Description
1	208627	Shank and Tee Bar Assembly
2	34331	5 Lb. Hammer
-	104820	Parts List

**No. 1156**  
Slide Hammer Unit

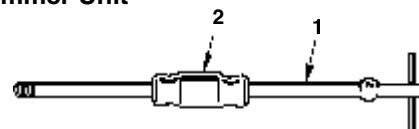

Item No.	Service Part No.	Description
1	208627	Shank and Tee Bar Assembly
2	22185	2 1/2 Lb. Hammer
-	104820	Parts List

**No. 1157  
1158**

**Slide Hammer Puller  
with Cup Pulling Attachment**

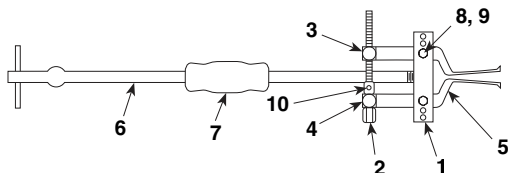

Item No.	Service Part No.	Description
1	33482	Slotted Block
2	24846	Adjusting Screw, 1/4 x 6.345
3	24847	Tapped Swivel
4	24848	Plain Swivel
5	32137	4" Clearance Jaw
6	208627	Shank & Tee Bar Assembly
7	22185	2 1/2 Lb. Hammer for 1157
7	34331	5 Lb. Hammer for 1158
8	10054	Hex Head Cap Screw
9	10386	Hex Jam Nut
10	11560	Roll Pin
-	104820	Parts List

**No. 1170  
1171  
1172**

**Pilot Bearing Puller**

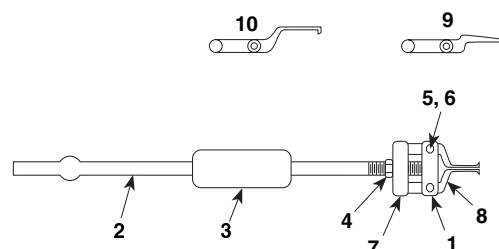

Item No.	Service Part No.	Description
1	27044	Cross Block
2	28382	Shank
3	28381	Hammer
4	10390	Adjusting Nut
5	10014	Hex Head Cap Screw
6	10382	Hex Jam Nut
7	201952	Adjusting Bar
8	29185	Jaw for 1170, 3/4" Reach
9	29189	Jaw for 1171, 1" Reach
10	29187	Jaw for 1172, 1 3/4" Reach

**No. 1165  
1166**

**Internal Pulling Attachment**

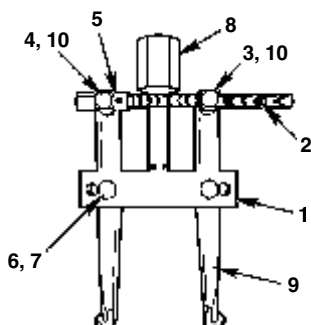

Item No.	Service Part No.	Description
1	33084	Slotted Block
2	33001	Adjusting Screw, 5/8 - 18 UNF-2A
3	27051	Tapped Swivel
4	27052	Plain Swivel
5	10896	Roll Pin
6	10105	Hex Head Cap Screw
7	10394	Hex Jam Nut
8	33578	Adapter, 1 1/2"-12, for 1165
8	38662	Adapter, 1 1/4"-7, for 1166
9	33083	Puller Jaw
10	10390	1/2" S.A.E. Jam Nut

**No. 1173  
1174**

**Slide Hammer Puller**

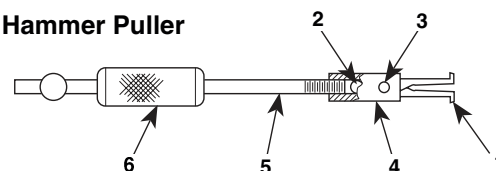

Item No.	Service Part No.	Description
1	43372	Puller Jaw
2	14472	Ball
3	14473	Pin
4	37016	Body
5	28382	Shank for 1173
6	28381	Hammer for 1173

FOR PRICE INFORMATION  
SEE OTC's MASTER PRICE LIST

**No. 1176**  
**1177**  
**1178**

**Reversible Jaw Slide Hammer Puller**

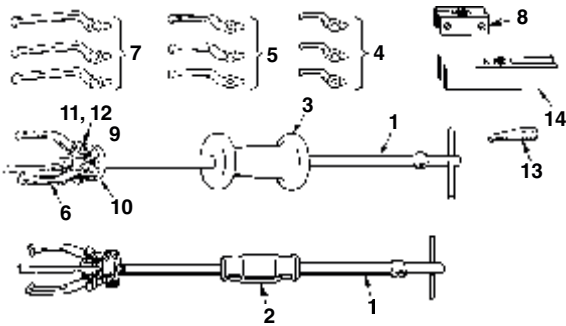

Item No.	Service Part No.	Description
1	208627	Shank & Tee Bar Assembly
2	22185	2 1/2 Lb. Hammer for 1176, 1178
3	34331	5 Lb. Hammer for 1177
4	32054	Pilot Brg. Jaw for 1178, 1 1/4" Reach
5	34698	Jaw, 2" Reach
6	44195	Jaw for 1178, 3" Reach
7	44148	Long Jaw for 1178, 5" Reach
8	27241	2-Way Cross Block Head
9	24544	3-Way Cross Block Head
10	24545	Adjusting Cone
11	22021	Hex Head Cap Screw
12	10384	Hex Jam Nut, 5/16-24
13	27315	Seal Hook for 1178
14	36578	Cross Block for 1178
-	104820	Parts List

**No. 1179**

**8-Way Slide Hammer**

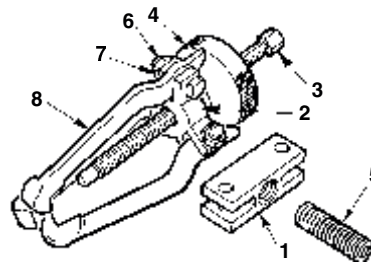
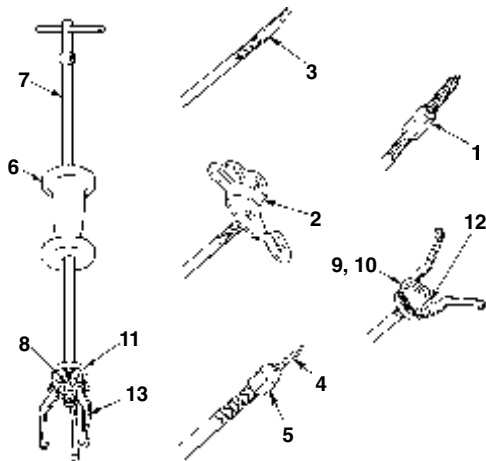

Item No.	Service Part No.	Description
1	205378	Grip Wrench Adapter
2	7372	Pulling Adapter
3	27315	Seal Hook
4	104427	Self-Tapping Screw
5	205399	Retainer
6	34331	5 Lb. Hammer
7	208627	Shank and Tee Bar Assembly
8	24544	3-Way Cross Head
9	10384	Hex Jam Nut, 5/16-24
10	22021	Hex Head Cap Screw, 5/16-24 x 1 1/8"
11	24545	Adjusting Cone
12	27241	2-Way Cross Block Head
13	34698	Puller Jaw
-	104820	Parts List

### No. 1189

#### 10-Way Slide Hammer Puller

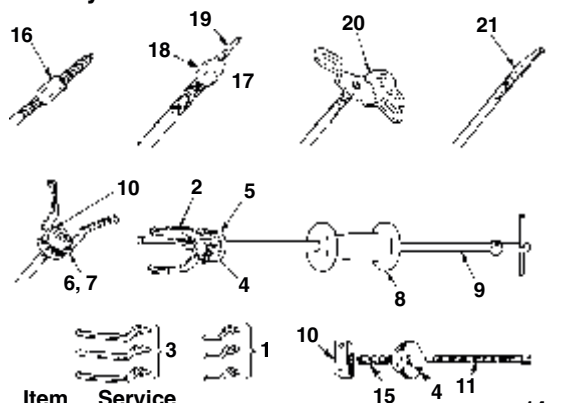

Item No.	Service Part No.	Description
1	32054	2 <sup>3</sup> / <sub>8</sub> " Jaw (each)
2	34698	3 <sup>3</sup> / <sub>4</sub> " Jaw (each)
3	44148	6 <sup>1</sup> / <sub>2</sub> " Jaw (each)
4	24544	3-Way Puller Head
5	24545	Adjusting Cone
6	10384	Hex Jam Nut, <sup>5</sup> / <sub>16</sub> -24
7	22021	Hex Head Cap Screw, <sup>5</sup> / <sub>16</sub> -24 x 1 <sup>1</sup> / <sub>8</sub> "
8	34331	5 Lb. Hammer
9	208627	Shank and Tee Bar Assembly
10	27241	Cross Block
11	309321	Forcing Screw, <sup>7</sup> / <sub>16</sub> -20 x 6.5"
12	47407	Puller Head
13	10394	Hex Jam Nut, <sup>5</sup> / <sub>8</sub> -18
14	24833	Forcing Screw, <sup>5</sup> / <sub>8</sub> -18 x 5"
15	215895	Sleeve
16	205378	Grip Wrench Adapter
17	205377	Dent Puller (consists of Nos. 18 & 19)
18	205399	Retainer
19	104427	Self-Tapping Screw, <sup>1</sup> / <sub>4</sub> " x 2"
20	7372	Puller Adapter
21	27315	Seal Hook
-	104820	Instruction Sheet

### No. 1201 1202 1203

#### 17<sup>1</sup>/<sub>2</sub>-Ton Hydraulic Sleeve Puller

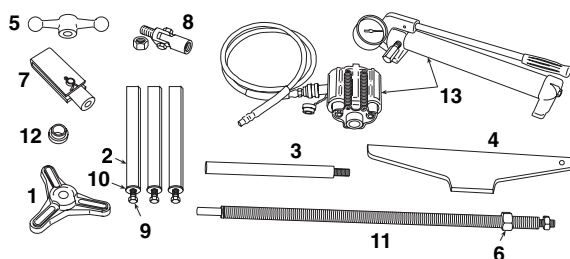

Item No.	Service Part No.	Description
1	37592	3-Way Head
2	27908	13" Riser Block (1 only)
3	33769	Screw Extension
4	41291	Installing Bar
5	302482	Speed Nut
6	10221	Hex Safety Nut
7	302340	Yoke Assembly for 1201
8	208675	Swivel Assembly
9	10088	Hex Head Cap Screw, <sup>1</sup> / <sub>2</sub> -13 x 2.00
10	10586	Flat Washer
11	32976	Pulling Screw
12	21714	Insert
13	4180	Hydraulic Pump/Ram Assy. for 1202
-	33768	Sleeve Installing Adapter
-	104856	Parts List

**Note:** 1201 consists only of 302340 Yoke Assembly, 33769 Screw Extension, 41291 Installing Bar, and 104856 Parts List.

### No. 1200

#### Manual Sleeve Puller Remover

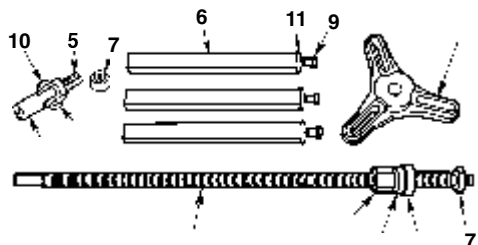

Item No.	Service Part No.	Description
1	22205	Hex Nut, 1"-8 UNC
2	24824	Thrust Washer (1.032)
3	37592	3-Way Head
4	32976	Forcing Screw
5	27914	Swivel
6	27908	13" Riser Block (each)
7	12121	Hex Nut, <sup>3</sup> / <sub>4</sub> -10 UNC
8	27912	Cap Screw, <sup>1</sup> / <sub>2</sub> -20
9	10088	Cap Screw, <sup>1</sup> / <sub>2</sub> -13
10	10390	Hex Jam Nut, <sup>1</sup> / <sub>2</sub> "
11	10586	Washer
12	11466	Thrust Bearing
13	33538	Swivel Adapter
-	104856	Parts List

FOR PRICE INFORMATION  
SEE OTC's MASTER PRICE LIST

**No. 1204  
1205**

**Universal Wet-Type Sleeve Puller**

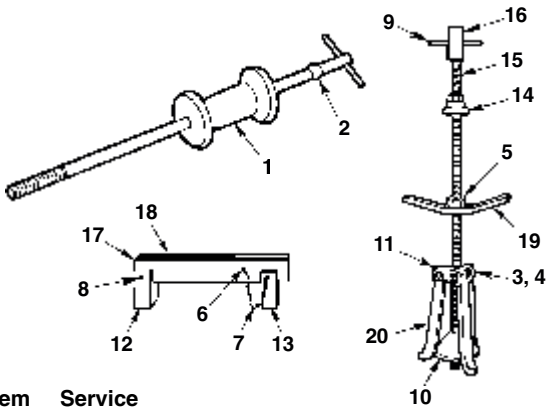

Item No.	Service Part No.	Description
1	34331	5 Lb. Slide Hammer for 1205
2	208627	Shank and Tee Bar Assembly for 1205
3	22016	Hex Head Cap Screw
4	10386	Hex Jam Nut, 3/8-24
5	10395	Hex Jam Nut, 5/8-11
6	10576	Round Head Drive Screw
7	12092	Safety Chain
8	12096	Roll Pin, 1/4" Dia., 2" Long
9	14252	Roll Pin, 1/4" Dia., 3 1/2" Long
10	28637	Cone
11	28638	3-Way Head
12	28698	Leg
13	28699	Leg
14	28700	Nut and Bearing Assembly
15	34126	Forcing Screw
16	34127	Adapter
17	34172	Plate
18	34173	Plate
19	34174	Locking Bar
20	41396	Jaw (1 only)
-	104842	Instruction Sheet

**No. 1266**

**Adjustable Gland Nut Wrench**

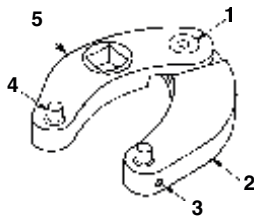

Item No.	Service Part No.	Description
1	19660	Flat Head Socket Screw
2	38710	Arm
3	10133	Set Screw
4	204928	Pin
5	43437	Arm

**No. 1722**

**500 Lb. Capacity Transverse Engine Support Bar**

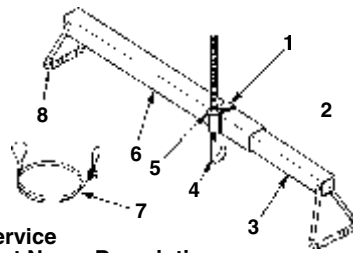

Item No.	Service Part No.	Description
1	210188	Slide
2	10206	Steel UNC Hex Nut, 7/16-14
3	43587	Support Arm
4	39006	Hook
5	13339	Washer
6	45628	Support Arm
7	39009	Sling
8	211090	Sleeve Protector
-	102506	Parts List

**No. 1724**

**700 Lb. Capacity 3-Bar Engine Support**

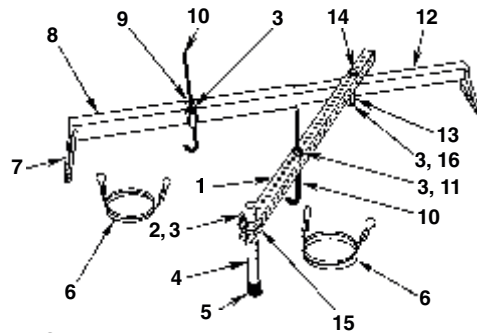

Item No.	Service Part No.	Description
1	308005	Pivot Support Arm
2	208608	Wing Nut
3	13339	Washer
4	308004	Pivot Support Leg
5	214067	Rubber Cap
6	39009	Cable
7	211090	Protective Sleeve
8	45628	Support Arm
9	210188	Slide
10	39006	Hook
11	10206	Hex Nut, 7/16-14
12	43587	Support Arm
13	214057	Slide
14	206050	Cap Screw, M10 x 1.5 x 110 mm
15	10057	Hex Head Cap Screw, 3/8-16 x 2"
16	19412	Hex Nut, M10 x 1.5
-	102506	Parts List
-	105194	Parts List



### No. 1805

2,000 Lb. Capacity Load-Rotor® Positioning Sling

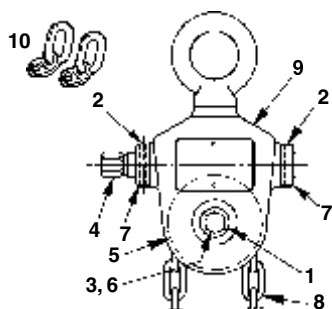

Item No.	Service Part No.	Description
1	10258	Washer
2	10973	Roll Pin
3	211185	Hex Head Cap Screw
4	23524	Worm
5	23525	Chain Block
6	211184	Pin
7	23728	Collar
8	31609	Chain Assembly
9	31627	Frame
10	24247	Lifting Bracket
-	102748	Parts List

### No. 1806

4,000 Lb. Capacity Load-Rotor® Positioning Sling

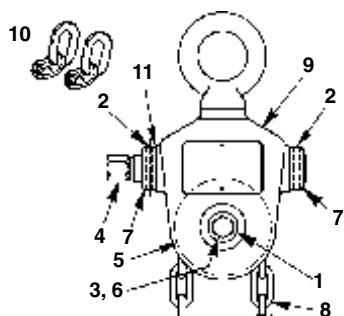

Item No.	Service Part No.	Description
1	13324	Washer
2	10973	Roll Pin
3	211187	Hex Head Cap Screw
4	31803	Worm
5	40569	Chain Block
6	211186	Pin
7	23728	Collar
8	31800	Chain Assembly
9	40568	Frame
10	24247	Lifting Bracket
11	214046	Shim Spacer
-	102748	Parts List

### No. 1812

6,000 Lb. Capacity Load-Rotor® Load Leveler

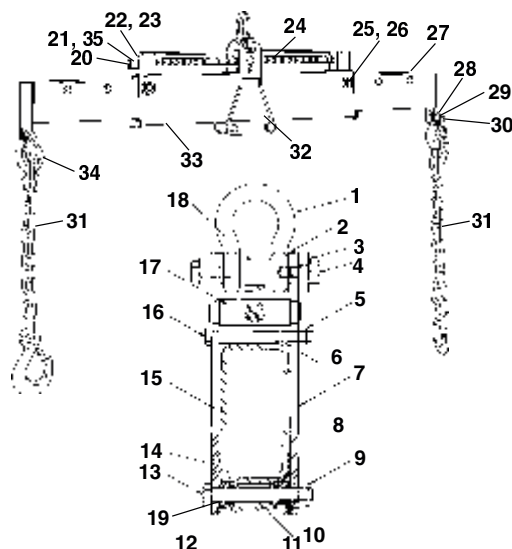

Item No.	Service Part No.	Description
1	206679	Anchor Shackle
2	12330	Washer (for 3/4" bolt)
3	12004	Washer (for 1/2" bolt)
4	10075	Hex Hd. Cap Screw, 1/2-13 x 3/4" Lg.
5	10204	Hex Nu, 3/8-16
6	206678	Spacer
7	11281	Trade Name Decal
8	302240	Roller
9	15013	Locknut (1/2-13; torque to 25-30 ft. lbs.)
10	209692	Needle Bearing
11	206680	Spacer
12	206681	Inner Bearing Race
13	13894	Hex Hd. Cap Screw, 1/2-13 x 3 3/4" Lg.
14	302225	Wear Pad
15	44240	Side Plate
16	14493	Hex Hd. Cap Screw, 3/8-16 x 3 3/4" Lg.
17	302244	Screw Block
18	302242	Pin
19	10303	O-ring, 7/8 x 3/4 x 1/16
20	206675	Nut
21	10585	Roll Pin
22	206746	Thrust Bearing
23	16209	Thrust Washer
24	302241	Screw
25	16726	Hex Hd. Cap Screw, 3/4-10 x 3-1/4" Lg.
26	10216	Hex Nut (3/4-10)
27	44242	Inner Tube
28	13324	Washer (for 5/8" bolt)
29	10213	Hex Nut (5/8-18)
30	22045	Hex Hd. Cap Screw, 5/8-18 x 2 1/2" Lg.
31	302941	Chain & Safety Hook
32	302284	Warning Decal
33	51726-WH2	Main Tube
34	16051	Eye Grab Hook
35	10481	Roll Pin
-	216819	Made in USA Decal
-	304524	Capacity Decal
-	102424	Parts List and Operating Instructions

FOR PRICE INFORMATION  
SEE OTC's MASTER PRICE LIST

## No. 1822

### 10,000 Lb. Capacity Load-Rotor® Load Leveler

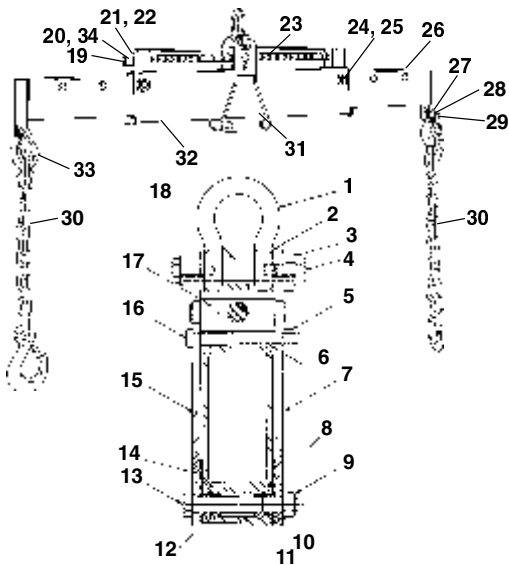

Item No.	Service Part No.	Description
1	208112	Anchor Shackle
2	208149	Spacer (for 3/4" bolt)
3	12004	Washer (for 1/2" bolt)
4	10075	Hex Hd. Cap Screw, 1/2-13 x 3/4" Lg.
5	207255	Hex Nut, 1/2-13
6	208110	Spacer
7	524674	Trade Name Decal
8	303452	Roller
9	12726	Locknut, 5/8-18; torque to 25-30 ft. lbs.
10	208087	Needle Bearing
11	208111	Spacer
12	208088	Inner Bearing Race
13	10465	Hex Hd. Cap Screw, 5/8-18 x 4 1/2" Lg.
14	303451	Wear Pad
15	52015	Side Plate
16	10094	Hex Hd. Cap Screw, 1/2-13 x 4 1/2" Lg.
17	44937	Screw Block
18	303450	Pin
19	206675	Nut
20	10585	Roll Pin
21	206746	Thrust Bearing
22	16209	Thrust Washer
23	303449	Screw
24	19340	Hex Hd. Cap Screw, 3/4-10 x 4" Lg.
25	10216	Hex Nut, 3/4-10
26	52013	Inner Tube (includes items 9, 10, 11, & 15)
27	13324	Washer (for 5/8" bolt)
28	10213	Hex Nut, 5/8-18
29	22045	Hex Hd. Cap Screw, 5/8-18 x 2 1/2" Lg.
30	302249	Chain & Safety Hook
31	303471	Warning Decal
32	61039-WH2	Main Tube
33	16051	Eye Grab Hook
34	10481	Roll Pin
—	304525	Capacity Decal
—	524675	Parts List/Operating Instructions

## No. 4240 4241

### 30-Ton King Pin / Brake Anchor Pin Pusher

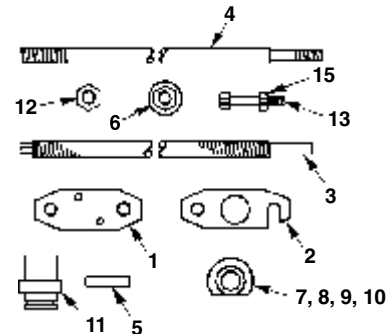

Item No.	Service Part No.	Description
1	43103	Ram Mounting Plate
2	43104	King Pin Pusher Head
3	34195	Forcing Screw
4	34193	Leg (2 reqd.)
5	28709	Pin
6	28714	Special Nut (2 reqd.)
7	34202	Bushing to 1"
8	34201	Bushing to 1 1/4"
9	34200	Bushing to 1 1/2"
10	34199	Bushng to 1 3/4"
11	29424	Anchor Pin Adapter
12	10220	Hex Nut, 1"-14 (3 reqd.)
13	10206	Hex Head Cap Screw, 7/16"-14 x 3"
—	309962	Bushing, 1 1/4 x 3 1/2" Long
—	102488	Parts List

**Note:** 4240 also includes 25599 Hose Half Coupler, 36886 Hose Assembly, 4002 Hydraulic Hand Pump, 4121 Power Twin Ram.

## No. 4324

### Engine Support Bar

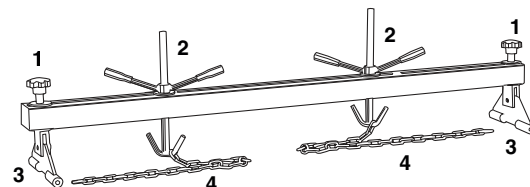

Item No.	Service Part No.	Description
1	517326	Knob with Washer
2	517329	Adjustable Hook Assembly
3	517327	Standing Bracket with Rubber Feet
4	517325	Chain
—	107339	Parts List

**No. 4489**  
5 Piece Interior Molding Remover



Item No.	Service Part No.	Description
1	4489-1	Wide Molding Remover
2	4489-2	Puller Molding Remover
3	4489-3	Narrow Molding Remover
4	4489-4	Molding Remover
5	4489-5	Clip Molding Remover

**No. 4492**  
4 Piece E-Clip Tool



Item No.	Service Part No.	Description
1	4492-1	Handle
2	4492-2	Blade Replacement Set

**No. 4503**  
Double Flaring Tool Set

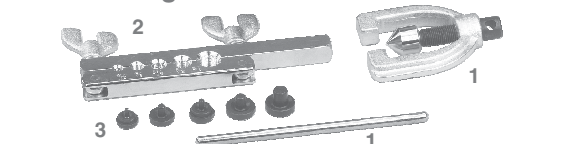

Item No.	Service Part No.	Description
1	4503-1	Yoke/Screw Assembly (including handle)
2	4503-2	Flaring Bar Assembly
3	4503-3	Set of Five Adapters 3/16", 1/4", 5/16", 3/8", and 1/2"

**No. 4504**  
Metric Bubble (ISO)  
Flaring Tool Set

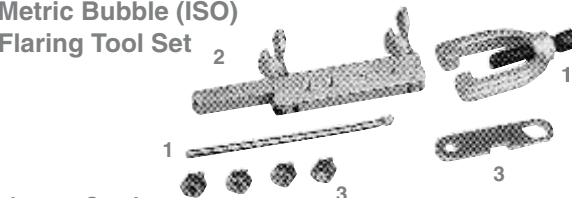

Item No.	Service Part No.	Description
1	4503-1	Yoke/Screw Assembly (including handle)
2	4503-2	Flaring Bar Assembly
3	4503-3	Gauge/Wrench and Four Adapters 4.75 mm (3/16"), 6 mm, 8 mm, and 10 mm

**No. 4505**  
Bushing Driver Set



Item No.	Service Part No.	Description
1	4505-1	Large Driver Handle with Nut
2	4505-2	Medium Driver Handle with Nut
3	4505-3	Small Driver Handle with Nut
4	4505-4	Nine Bushing Adapters 47/64" to 13/8"; Use with 4505-1
5	4505-5	Seven Bushing Adapters 3/8" to 13/16"; Use with 4505-2 or 4505-3
6	—	Carrying Case (Check for availability)

**No. 4507**  
Bearing Race and Seal Driver



Item No.	Service Part No.	Description
1	4507-1	1.565" Driver
2	4507-2	1.750" Driver
3	4507-3	1.965" Driver
4	4507-4	2.325" Driver
5	4507-5	2.470" Driver
6	4507-6	2.555" Driver
7	4507-7	2.830" Driver
8	4507-8	2.995" Driver
9	4507-9	3.180" Driver
10	4507-10	Driver Handle with Bolt
11	—	Carrying Case (Check for availability)

**No. 4508**  
Seal Remover



Item No.	Service Part No.	Description
1	4508-1	Blade

FOR PRICE INFORMATION  
SEE OTC's MASTER PRICE LIST

**No. 4512**  
**Snap Ring Pliers Set**  
**Internal/External**

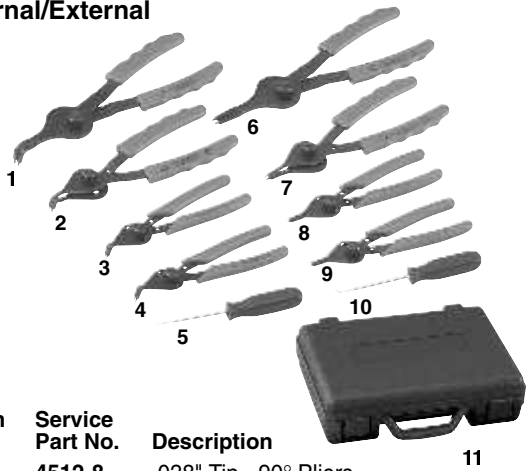

Item No.	Service Part No.	Description
1	4512-8	.038" Tip - 90° Pliers
2	4512-6	.047" Tip - 90° Pliers
3	4512-4	.070" Tip - 90° Pliers
4	4512-2	.090" Tip - 90° Pliers
5	4512-9	Straight Tip Pick
6	4512-7	.038" Tip - Straight Pliers
7	4512-5	.047" Tip - Straight Pliers
8	4512-3	.070" Tip - Straight Pliers
9	4512-1	.090" Tip - Straight Pliers
10	4512-10	90° Tip Pick
11	—	Carrying Case (Check for availability)

**No. 4518**  
**5-Ton Bar-Type Puller/Bearing Splitter Set**

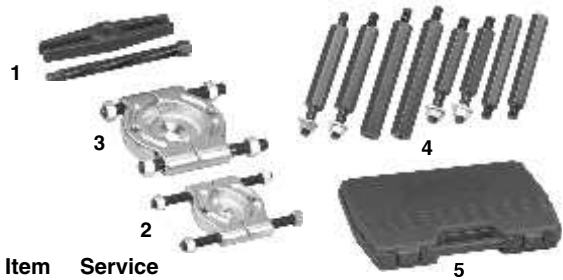

Item No.	Service Part No.	Description
1	4518-1	5" Pull Cross-bar/Forcing Screw, 6 <sup>1</sup> / <sub>2</sub> "
2	4518-3	Large Bearing Splitter
3	4518-2	Small Bearing Splitter
4	4518-4	Push-Puller Leg Set
5	—	Carrying Case (Check for availability)

**No. 4520**  
**Differential Side Bearing Puller**

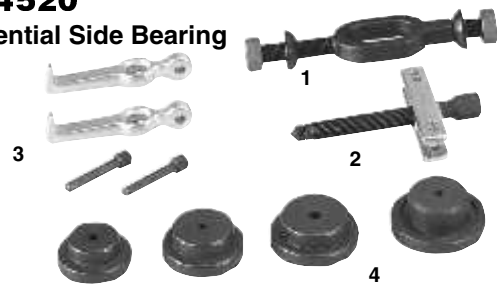

Item No.	Service Part No.	Description
1	4520-3	Puller Jaws Retaining Yoke
2	4520-1	Forcing Screw/Cross Block Assembly
3	4520-2	Puller Jaw/Pins (2)
4	4520-4	Puller Jaw Adapter Set 1 <sup>5</sup> / <sub>16</sub> "–1 <sup>11</sup> / <sub>32</sub> " dia. 1 <sup>1</sup> / <sub>8</sub> "–1 <sup>1</sup> / <sub>2</sub> " dia. 1 <sup>1</sup> / <sub>4</sub> "–1 <sup>5</sup> / <sub>8</sub> " dia. 1 <sup>1</sup> / <sub>8</sub> "–1 <sup>3</sup> / <sub>4</sub> " dia.

**No. 4513**  
**Heavy-Duty Snap Ring Plier Set**

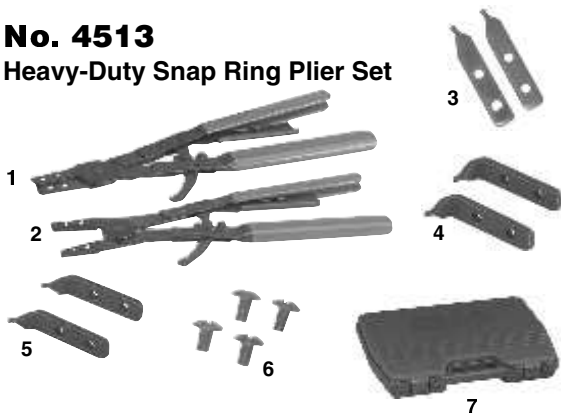

Item No.	Service Part No.	Description
1	4513-1	Internal Pliers (3 <sup>1</sup> / <sub>16</sub> " to 6 <sup>1</sup> / <sub>4</sub> " snap rings)
2	4513-2	External Pliers (3 <sup>1</sup> / <sub>2</sub> " to 6 <sup>1</sup> / <sub>2</sub> " snap rings)
3	4513-3	Straight Tip, .12" (3 mm)
4	4415-4	45° Tip, .12" (3mm)
5	4415-5	90° Tip, .12" (3 mm)
6	4415-6	Four Tip Retaining Screws
7	—	Carrying Case (Check for availability)

**No. 4528**  
**Clutch Alignment Tool Set**

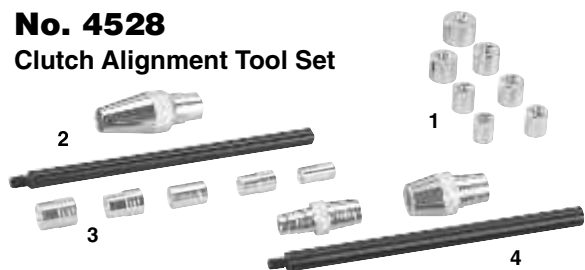

Item No.	Service Part No.	Description
1	4528-1	7 SAE Pilot Adapters
2	4528-2	SAE Alignment Shaft with Aligner
3	4528-3	5 Metric Pilot Adapters
4	4528-4	Metric Alignment Shaft with 2 Aligners

**No. 4529**  
**Power Steering/Alternator Pulley  
Puller/Installer Set**

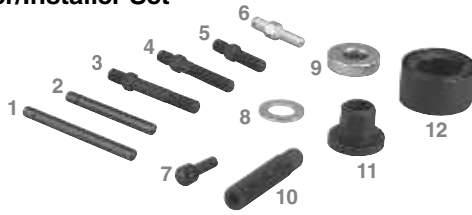

Item No.	Service Part No.	Description
1	4529-7	Remover Pin (GM Quad 4 engines)
2	4529-8	Remover Pin (GM 3.1L, 3100, and 3400 V-6 Engines)
3	4529-9	Installer Screw (GM Quad 4 Engines)
4	4529-10	Installer Screw (GM 3.1L, 3100, 3400 V-6 Engines)
5	4529-11	Installer Screw (Used on Most Vehicles)
6	4529-12	Installer Screw (Ford Modular V-8 Engines)
7	4529-4	Remover Pin (Used on Most Vehicles)
8	4529-6	Washer (For Installing)
9	4529-5	Thrust Bearing (For Installing)
10	4529-3	Installer/Remover Forcing Screw
11	4529-1	Installer/Remover Nut
12	4529-2	Remover/Assembly, 2-piece Jaws and Sleeve

**No. 4530**  
**Power Steering Pump  
Pulley Service Set**



Item No.	Service Part No.	Description
1	312347	Forcing Screw, 8 mm x 1.25
2	312346	Special Nut
3	7185	Pump/Alternator Pulley Remover (Consists of: 208703 Sleeve, 304108 Collet Half, 304107 Nut, 27445 Forcing Screw Assembly)
4	7104	GM Pump Pulley Removal Screw (Consists of: 27445 Forcing Screw, 10378 Steel Ball, 310901 Long Nose Cone, and 10266 O-ring)
5	217946	Hex Head Cap Screw, 3/8 - 16 x 4"
6	7931	Chrysler Pump Pulley Spacer
7	—	Carrying Case (Check for availability)

**No. 4531**  
**Harmonic Balancer Puller/Installer Set**

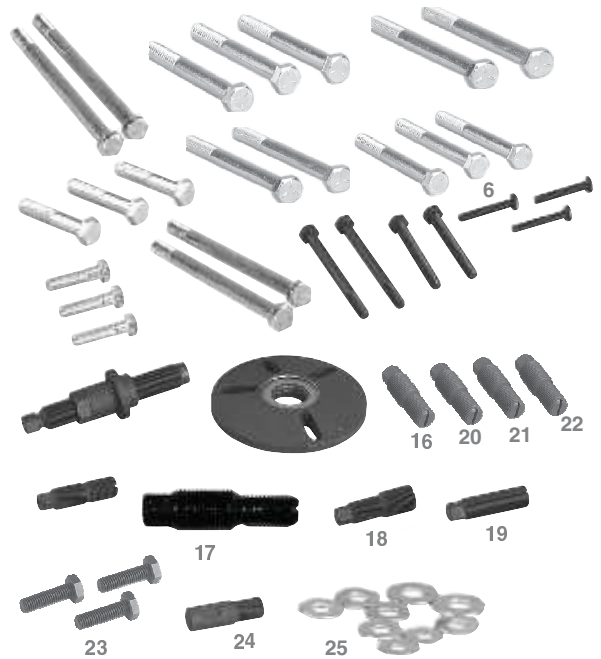

Item No.	Service Part No.	Description
1	4531-1	Cap Screw Set, 5/16 x 6
2	4531-2	Cap Screw Set, 5/16 x 3 1/2
3	4531-3	Cap Screw Set, 5/16 x 3
4	4531-4	Cap Screw Set, 3/8 x 1 1/2
5	4531-5	Cap Screw Set, 1/4 x 2 1/2
6	4531-6	Cap Screw Set, 3/8 x 3
7	4531-7	Cap Screw Set, 3/8 x 4 1/2
8	4531-8	Cap Screw Set, 3/8 x 2
9	4531-9	Puller Screw
10	4531-10	Cap Screw Set, M8 x 90
11	4531-11	Cap Screw Set, M8 x 65
12	4531-12	Cap Screw Set, M8 x 45
13	4531-13	Puller Flange
14	4531-14	Puller Body
15	4531-16	Adapter, M16 x 2.0
16	4531-17	Adapter, M14 x 1.5
17	4531-18	Adapter, M12 x 1.5
18	4531-19	3/4 Adapter
19	4531-20	5/8 Adapter
20	4531-21	9/16 Adapter
21	4531-22	1/2 Adapter
22	4531-23	7/16 Adapter
23	4531-24	Cap Screw Set, M10 x 35
24	4531-25	Centering Adapter
25	4531-26	Washer Set

FOR PRICE INFORMATION  
SEE OTC's MASTER PRICE LIST

**No. 4533**  
GM Strut Tool



Item No.	Service Part No.	Description
1	4533-2	Handle Driver
2	4533-1	Socket

**No. 4534**  
Multipurpose Bearing & Pulley Puller Set

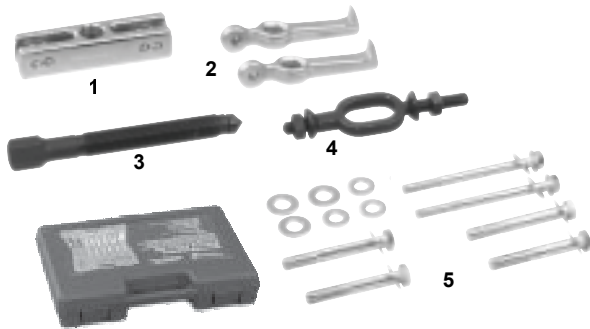

Item No.	Service Part No.	Description
1	4534-1	Puller Block (Small)
2	4534-2	2-piece Jaw Set (Medium)
3	4534-3	Forcing Screw (Long)
4	4534-4	Adjusting Yoke (Small)
5	4534-5	Washer and Bolt Set
6	—	Carrying Case (Check for availability)

**No. 4536**  
A/C Clutch Pulley Puller Set



Item No.	Service Part No.	Description
1	4536-1	Puller Block
2	4536-2	Forcing Screw
3	4536-3	Live Center Tip
4	4536-4	2-piece Short Jaw Set
5	4536-5	2-piece Long Jaw Set
6	4536-6	2-piece Detent Pin
7	4536-7	Adjusting Yoke

**No. 4542**  
7-Piece Wheel/Bearing Locknut Socket Set

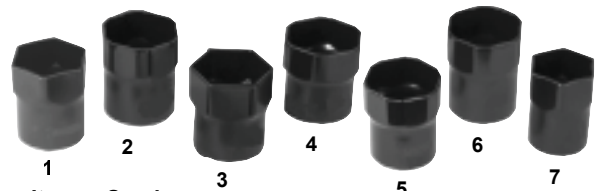

Item No.	Service Part No.	Description
1	519097-1	2 <sup>3</sup> / <sub>8</sub> " Hex Locknut Socket
2	519097-2	2 <sup>9</sup> / <sub>16</sub> " Round Hex Locknut Socket
3	519097-3	2 <sup>1</sup> / <sub>2</sub> " Hex Locknut Socket
4	519097-4	2 <sup>3</sup> / <sub>4</sub> " Round Hex Locknut Socket
5	519097-5	2 <sup>1</sup> / <sub>2</sub> " Round Hex Locknut Socket
6	519097-6	2 <sup>3</sup> / <sub>8</sub> " Round Hex Locknut Socket
7	519097-7	55 mm Locknut Socket

**No. 4535**  
A/C Clutch Hub Remover/Installer Set

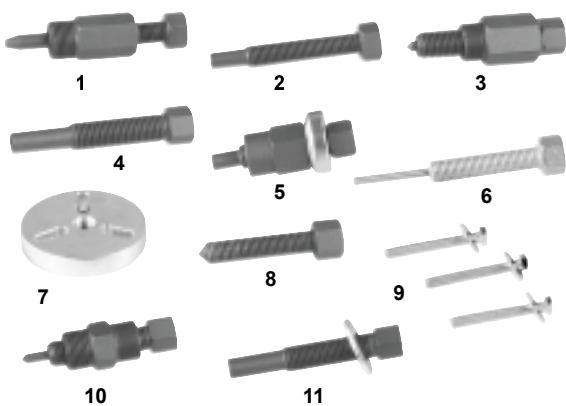

Item No.	Service Part No.	Description
1	4535-1	Nut and Forcing Screw Assembly
2	4535-2	Forcing Screw
3	4535-3	Nut/Forcing Screw Assembly
4	4535-4	Forcing Screw
5	4535-5	Nut/Forcing Screw/Bearing Assembly
6	4535-6	Forcing Screw
7	4535-7	Remover Plate
8	4537-8	Forcing Screw
9	4538-9	3-piece Screw/Washer Set
10	4535-10	Nut/Forcing Screw Assembly
11	4535-11	Forcing Screw Washer Assembly

**No. 4543**  
4-Wheel Drive Spindle Nut Socket Set

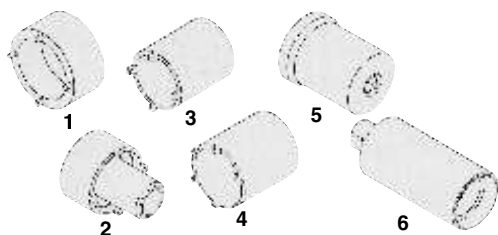

Item No.	Service Part No.	Description
1	4543-1	Toyota Locknut Socket
2	4543-2	Ford Locknut Socket
3	4543-3	Ford Locknut Socket
4	4543-4	GM Locknut Socket
5	4543-5	Ford Locknut Socket
6	4543-6	Spindle Remover Adapter

**No. 4546**  
Steering Wheel and Pedal Holder

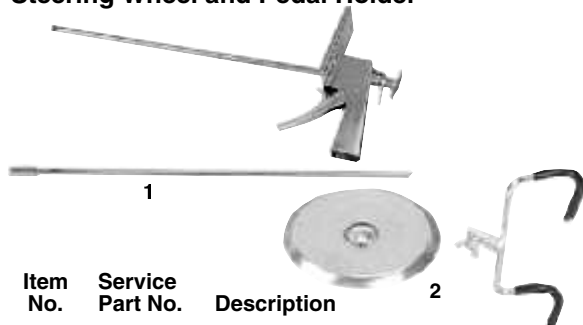

Item No.	Service Part No.	Description
1	4546-1	Handle and Rod
2	4546-2	Steering Wheel and Pedal Holder

**No. 4547**  
Front Wheel Drive Axle Nut Socket Set



Item No.	Service Part No.	Description
1	4547-29	29 mm Socket
2	4547-30	30 mm Socket
3	4547-32	32 mm Socket
4	4547-34	34 mm Socket
5	4547-35	35 mm Socket
6	4547-36	36 mm Socket
7	4547-38	38 mm Socket

**No. 4549**  
Upholstery Tools



Item No.	Service Part No.	Description
1	4549-3	Large Panel Clip Tool
2	4549-2	Small Panel Clip Tool
3	4549-1	9" Door Clip Tool

**No. 4550**  
3-Piece Scraper Set



Item No.	Service Part No.	Description
1	4550-1	2" Straight Blade
2	4550-2	1 1/4" Straight Blade
3	4550-3	1 1/4" Bent Blade

**No. 4551**  
Small Door Panel and Upholstery Tools



Item No.	Service Part No.	Description
1	4551-1	U Panel Clip Tool
2	4551-2	V Panel Clip Tool

**No. 4552**  
Putty Knife



Item No.	Service Part No.	Description
1	4552-1	Large Putty Knife
2	4552-2	Medium Putty Knife
3	4552-3	Small Putty Knife

FOR PRICE INFORMATION  
SEE OTC's MASTER PRICE LIST

### No. 4559

#### Manual/Pneumatic Pickle Fork

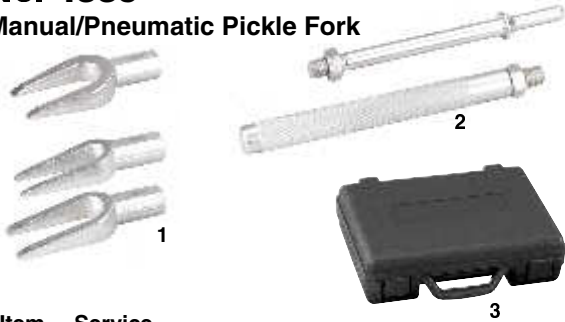

Item No.	Service Part No.	Description
1	4559-1	Pickle Fork Replacement Set
2	4559-2	Pickle Fork Driver Set
3	—	Carrying Case (Check for availability)

### No. 4585

#### Five-piece Fan Clutch Wrench



Item No.	Service Part No.	Description
1	4585-5	Holding, 76 mm (3") & 68 mm (2 <sup>11</sup> / <sub>16</sub> " ) Wrench
2	4585-4	Turning Wrench, 40 mm (1 <sup>1</sup> / <sub>2</sub> " )
3	4585-3	Holding Wrench, 72 mm (2 <sup>13</sup> / <sub>16</sub> " ) & 54 mm (2 <sup>1</sup> / <sub>8</sub> " )
4	4585-2	Holding Wrench, 83 mm (3 <sup>1</sup> / <sub>4</sub> " )
5	4585-1	Turning Wrench, 48 mm (1 <sup>7</sup> / <sub>16</sub> " )

### No. 4572

#### Valve Spring Compressor

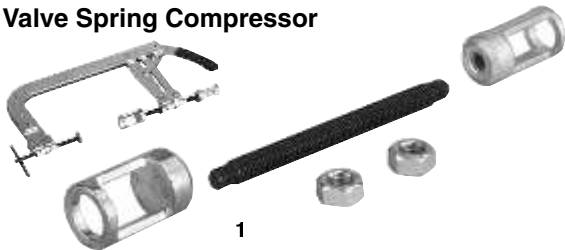

Item No.	Service Part No.	Description
1	4572-1	Valve Spring Adapters, Screw, and Nuts

### No. 4600

#### 16 Piece Punch and Chisel Set



Item No.	Service Part No.	Description
1	4600-15	Taper Punch, 1/4 x 6 <sup>3</sup> / <sub>4</sub>
2	4600-14	Taper Punch, 3/16 x 6 <sup>1</sup> / <sub>4</sub>
3	4600-13	Taper Punch, 5/32 x 6
4	4600-3	Cold Chisel, 3/8 x 5 <sup>1</sup> / <sub>2</sub> 6
5	4600-2	Cold Chisel, 1/2 x 6 4
6	4600-1	Cold Chisel, 5/8 x 6 <sup>1</sup> / <sub>2</sub>
7	4600-4	Center Punch, 3/16 x 8 46
8	4600-5	Center Punch, 1/8 x 5 46
9	4600-12	Taper Punch, 1/8 x 5 <sup>3</sup> / <sub>4</sub>
10	4600-11	Taper Punch, 3/32 x 5 <sup>1</sup> / <sub>4</sub>
11	4600-10	Pin Punch, 3/32 x 4 <sup>1</sup> / <sub>4</sub> 4603-2
12	4600-9	Pin Punch, 1/8 x 4 <sup>3</sup> / <sub>4</sub>
13	4600-8	Pin Punch, 5/32 x 5 46
14	4600-7	Pin Punch, 3/16 x 5 <sup>1</sup> / <sub>4</sub> 46
15	4600-6	Pin Punch, 1/4 x 5 <sup>3</sup> / <sub>4</sub> 46
16	4600-16	Chisel Gauge

### No. 4581

#### Blind Hole Bearing Puller Set

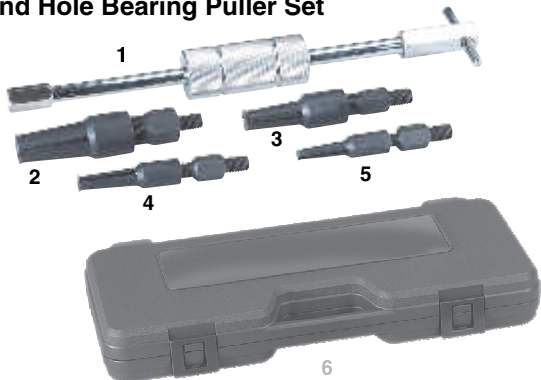

Item No.	Service Part No.	Description
1	4581-5	Slide Hammer Assembly
2	4581-4	1 <sup>1</sup> / <sub>4</sub> " Collet / Pin Assembly
3	4581-3	1" Collet / Pin Assembly
4	4581-2	3/4" Collet / Pin Assembly
5	4581-1	1/2" Collet / Pin Assembly
6	—	Carrying Case (Check for availability)





**No. 4604**  
Frost Plug Installer

Item No.	Service Part No.	Description
1	4604-1	Driver
2	4604-2	Disc Set
4	—	Carrying Case (Check for availability)

**No. 4605**  
Punch/Chisel Set



Item No.	Service Part No.	Description
1	4605-1	Drive Handle
2	4605-9	1/4" Taper Punch
3	4605-12	1/8" Center Punch
4	4605-13	3/16" Center Punch
5	4605-11	1/4" Pin Punch
6	4605-10	3/16" Pin Punch
7	4605-8	1/8" Taper Punch
8	4605-2	1/2" Wide Flat Chisel
9	4605-3	5/8" Wide Flat Chisel
10	4605-7	1/4" Cape Chisel
11	4605-4	3/4" Wide Flat Chisel
12	4605-6	1" Wide Flat Chisel
13	4605-5	7/8" Wide Flat Chisel

**No. 4606**  
Hammer/Punch Set

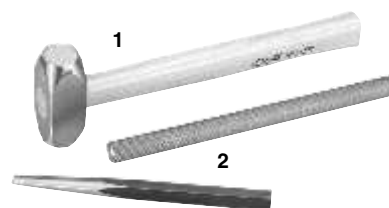

Item No.	Service Part No.	Description
1	4606-1	Hammer
2	4602	2-Piece Brass Punch Set

**No. 4607**  
**4608**  
Impact Driver Set



Item No.	Service Part No.	Description
1	4607-1	8 Bits, (Consists of: Two No. 2 Phillips bits: 1 <sup>3</sup> / <sub>8</sub> " long with 5/16" hex and 3 <sup>1</sup> / <sub>8</sub> " long with 5/16" hex Two No. 3 Phillips bits: 1 <sup>3</sup> / <sub>8</sub> " long with 5/16" hex and 3 <sup>1</sup> / <sub>8</sub> " long with 5/16" hex One each of the following: 5/16" wide x 1 <sup>3</sup> / <sub>8</sub> " long with 5/16" hex slotted bit; 5/16" wide x 3 <sup>1</sup> / <sub>8</sub> " long with 5/16" hex slotted bit; 3/8" wide x 1 <sup>3</sup> / <sub>8</sub> " long with 5/16" hex slotted bit; 3/8" wide x 3 <sup>1</sup> / <sub>8</sub> " long with 5/16" hex slotted bit)
2	—	Not replaceable

FOR PRICE INFORMATION  
SEE OTC's MASTER PRICE LIST



**No. 4651**  
**Screw Extractor Set**

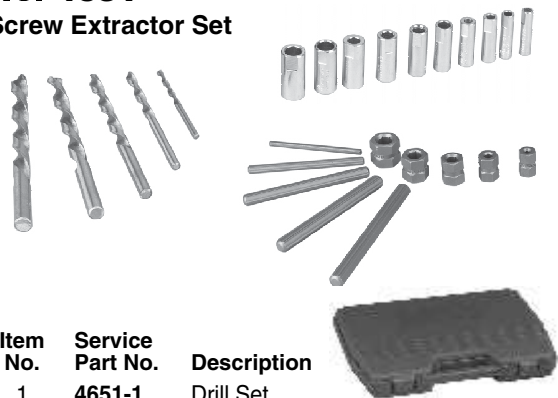

Item No.	Service Part No.	Description
1	4651-1	Drill Set
2	4651-2	Guide Set
3	4651-3	Extractor Set
4	—	Carrying Case (Check for availability)

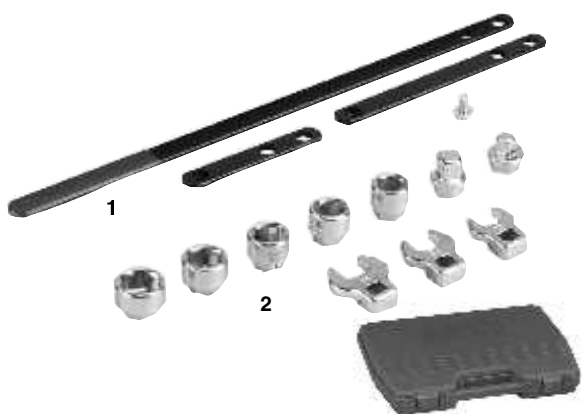

**No. 4681**  
Pulley Remove and Installer



Item No.	Service Part No.	Description
1	4681-2	Forcing Screw and Bearings
2	4681-1	Pullery Body



**No. 4756**  
Autobody  
Chisel  
Parts



Item No.	Service Part No.	Description
1	4756-1	Small Curve Tool
2	4756-2	Cross Curve Tool
3	4756-3	Rounded Ball Peen Tool
4	4756-4	One-sided Flat Blade Tool
5	4756-5	Curve Blade Tool
6	4756-6	Pointed Ball Peen Tool
7	4756-7	Angle Face Tool
8	4756-8	Flat Blade Tool
9	4756-9	Square Face Tool
10	4756-10	Angle Groove Tool
11	4756-11	Roune Face Tool
12	—	Carrying Case (Check for Availability)
13	4605-1	Handle

**No. 4711**  
Deluxe Radio and Antenna Service Kit



Item No.	Service Part No.	Description
1	4711-1	Antenna Sockets and Wrench Kit
2	4411-2	Radio Socket Kit

**No. 4726**  
Circlip Tool Tips

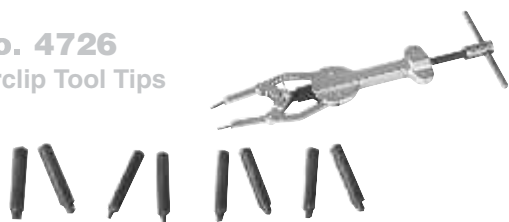

Item No.	Service Part No.	Description
1	4726-1	Eight Tips
2	—	Snap Ring Tool (Not Replaceable)

**No. 4752**  
Vacuum / Pressure Pump Kit

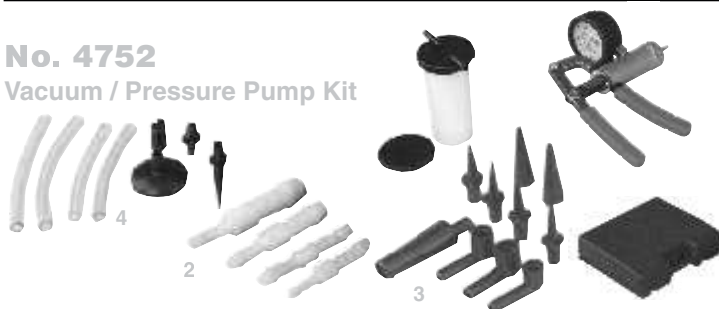

Item No.	Service Part No.	Description
1	4752-1	Plastic Bottle and Lid
2	4752-2	Inserts
3	4752-3	Inserts
4	4752-4	Inserts and Hoses
5	—	Pump (Not Replaceable)
6	—	Carrying Case (Check for Availability)

FOR PRICE INFORMATION  
SEE OTC's MASTER PRICE LIST

**No. 5020  
5021**  
Diesel Compression Tester

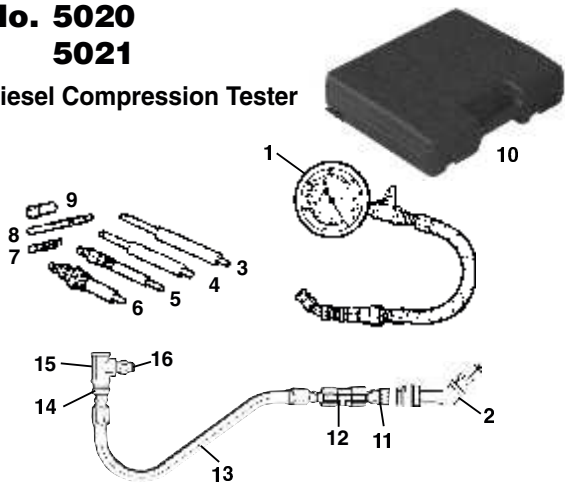

Item No.	Service Part No.	Description
1	45549	Compression Tester
2	217720	Quick Coupler Fitting
3	310810	Compression Test Adapter
4	310840	Compression Test Adapter
5	47484	Compression Test Adapter
6	217791	B-Engine Injector Adapter
7	310832	Glow Plug Adapter
8	308472	Glow Plug Adapter
9	SKW40412	6 Pt., 3/8 Drive Socket Glow Plug
10	308343	Carrying Case
11	209751	Quick Coupler, Socket Half
12	209750	Check Valve
13	209762	12" Compression Hose With 1/8 NPTF Male Ends
14	206324	Straight Fitting
15	214802	Tee Fitting
16	209749	Bleed Valve
-	48570	Inside Lid Decal
-	62337	Carrying Case Foam Insert

**No. 5022**  
Oil Seal / Wear Ring Installer

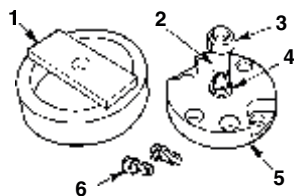

Item No.	Service Part No.	Description
1	04-149-3-2B	Wear Sleeve and Seal Adapter
2	11536	Socket Head Cap Screw
3	10215	Hex Nut
4	24837	Forcing Screw Washer
5	04-149-3-1A	Attaching Plate
6	17265	Screw, 5/8-18 x 1

**No. 5023**  
Diesel Injector Seat Cleaner

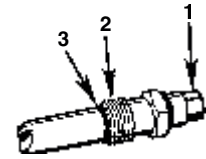

Item No.	Service Part No.	Description
1	45172	Nozzle Seat Reamer
2	208392	Threaded Sleeve
3	10302	O-ring

**No. 5024**  
Navistar Injector Sleeve  
Remover / Installer

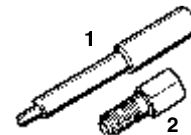

Item No.	Service Part No.	Description
1	ZTSE2534A	Nozzle Sleeve Installer
2	ZTSE2587A	Nozzle Sleeve Remover

**No. 5028**  
Slide Hammer Puller

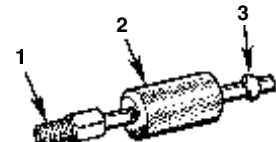

Item No.	Service Part No.	Description
1	206437	Reducing Adapter
2	208911	Hammer
3	208912	Shank

### No. 5039

#### Charged Air Cooler Tester

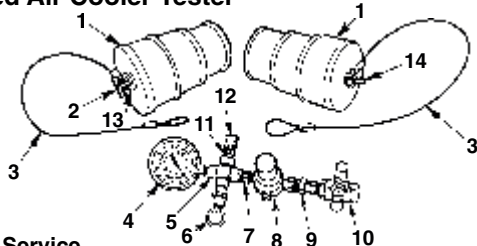

Item No.	Service Part No.	Description
1	48997	Hose Adapter
2	220194	Drain Cock Valve

### No. 5040

#### Cummins Injector Remover / Installer

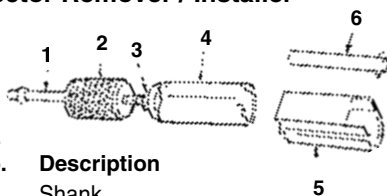

Item No.	Service Part No.	Description
1	312328	Shank
2	219779	Hammer
3	10210	Hex Nut, 1/2-20 UNF
4	219758	Installer (L10 Celect)
5	312013	Installer (N14 Celect)
6	312012	Pin-Type Puller Adapter
-	307382	Carrying Case
-	43135	Carrying Case Foam Insert

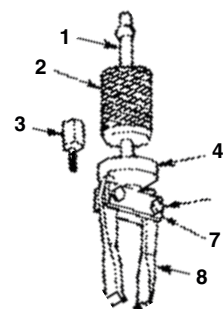

### No. 5041

#### Cummins Rocker Box Setting Tool

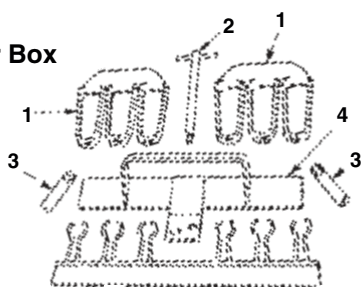

Item No.	Service Part No.	Description
1	312420	Push Tube Guide
2	312418	Tee Handle
3	220266	Guide Pin
4	53919	Mounting Plate
5	312419	Push Tube Guide
-	12368	Cap Screw
-	105829	Parts List

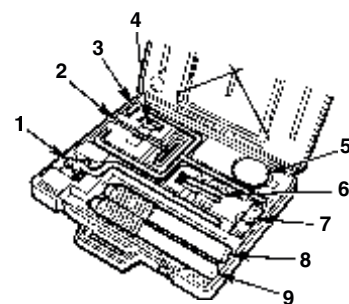

FOR PRICE INFORMATION  
SEE OTC's MASTER PRICE LIST

**No. 5048  
5049**  
Flywheel Pilot Bearing  
Puller

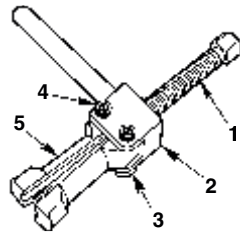

Item No.	Service Part No.	Description
1	312548	Forcing Screw
2	312549	Puller Body
3	10199	Hex Nut, 1/4-20
4	10022	Screw
5	312551	Puller Jaw for 5048
5	312552	Puller Jaw for 5049

**No. 5051**  
Eaton® / Fuller®  
Bearing Puller Set

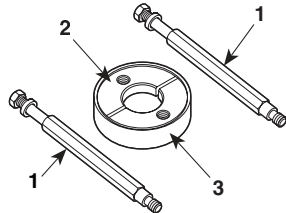

Item No.	Service Part No.	Description
1	313579	Leg
2	440089	Collet Half
3	221645	Sleeve

**No. 5052**  
Slack Check

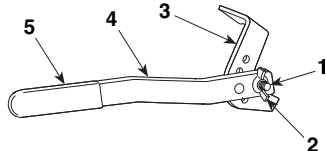

Item No.	Service Part No.	Description
1	220001	Carriage Bolt
2	13024	Wing Nut, 1/4-20
3	49225	Slack Adjuster Head
4	312174	Handle
5	14564	Handle Grip

**No. 5055  
5056**  
Slack Adjuster  
Puller

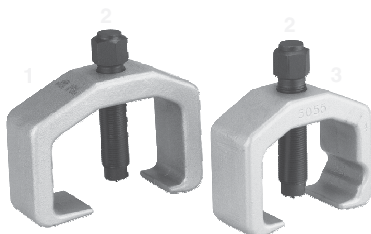

Item No.	Service Part No.	Description
1	49704	Slack Adjuster Puller for 5056
2	26619	Forcing Screw
3	49702	Slack Adjuster Puller for 5055

**No. 5062**  
Auxiliary Countershaft  
Shim Tool

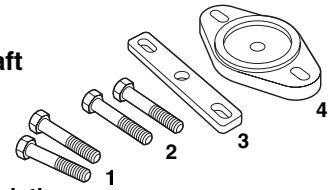

Item No.	Service Part No.	Description
1	19834	Hex Head Cap Screw, 3/8-16 x 2.75"
2	212336	Hex Head Cap Screw, Metric, 12 mm - 1.75 x 70 mm Long
3	313580	Plate
4	440090	Shim Gauge

**No. 5063**  
Eaton® / Fuller® Timing Tool

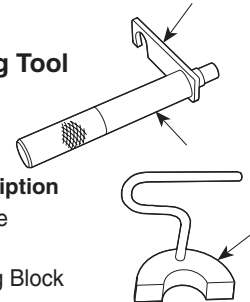

Item No.	Service Part No.	Description
1	313643	Handle
2	313642	Plate
3	313644	Timing Block

**No. 5064**  
Eaton® / Fuller® Countershaft  
Pushing Tool

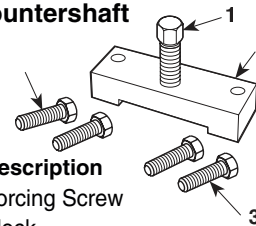

Item No.	Service Part No.	Description
1	24426	Forcing Screw
2	440091	Block
3	217871	Hex Head Cap Screw
4	216295	Hex Head Cap Screw, Metric

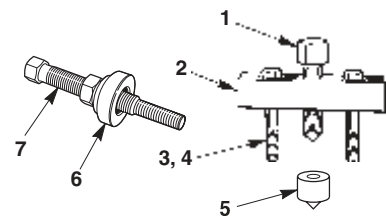

### No. 5901

#### Seat Belt Bolt Removal Tool



Item No.	Service Part No.	Description
1	520463	T47 Torx Bit
2	517923	Bit Holder

### No. 6284

#### GM/Chrysler Harmonic Balancer Puller and Holding Ring Set



Item No.	Service Part No.	Description
1	6267	Puller Set (includes 3-jaw puller, 3 forcing rods, and a 3/8" square drive forcing screw)
2	516638	Forcing Rods (3)
3	6495	Holding Tool
-	514822	Carrying Case
-	107368	Instruction Sheet

### No. 6292

#### Bushing Puller

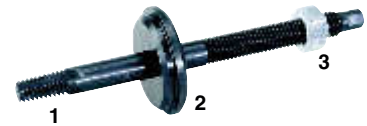

Item No.	Service Part No.	Description
1	MLR-SP-1192A	Screw
2	MLR-SP-1193	Adapter
3	10211	Hex Nut, 9/16-12 UNC

### No. 6293

#### Bushing Installer/Reamer

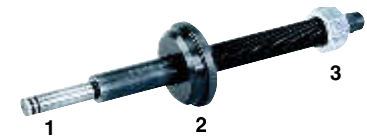

Item No.	Service Part No.	Description
1	MLR-SP-1199A	Screw
2	MLR-SP-1200	Adapter
3	10215	Hex Nut

### No. 6294

#### Master Bolt Grip Set

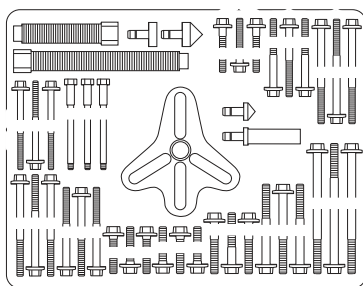

Item No.	Service Part No.	Description
1	511039	Forcing Screw, 3/4" Short
2	511038	Adapter (Short)
3	511034	Center, Large

4	511028	Washer Head Bolt, M8 x 1.25 x 45 mm
5	511031	Washer Head Bolt, M8 x 1.25 x 65 mm
6	511027	Washer Head Bolt, M8 x 1.25 x 90 mm
7	511036	Forcing Screw, 3/4"
8	511030	Washer Head Bolt, 1/4 - 28 UNF x 3"
9	222191	Screw, Special
10	511035	Flange, 3/4" Puller
11	511037	Center, Small
12	511033	Adapter, Long
13	511040	Washer Head Bolt, 5/16 -18 UNC x 3.5"
14	511032	Washer Head Bolt, 5/16 -24 UNF x 3"
15	511041	Washer Head Bolt, 3/8 -24 UNF x 1.5"
16	511045	Washer Head Bolt, M10 x 1.5 x 35 mm
17	511042	Washer Head Bolt, 3/8 -16 UNC x 2.0"
18	511043	Washer Head Bolt, 3/8 -16 UNC x 3.0"
19	511044	Washer Head Bolt, 3/8 -16 UNC x 4.5"
20	514232	Plastic Tray
-	107206	Parts List

FOR PRICE INFORMATION  
SEE OTC's MASTER PRICE LIST



**No. 6494**  
**Clamshell Strut Spring Compressor**

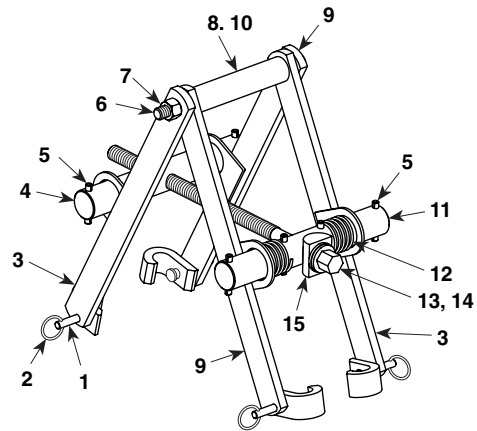

Item No.	Service Part No.	Description
1	217183	Clevis Pin, 1 <sup>3</sup> / <sub>4</sub> " Long
2	213876	Split Ring
3	516238	Short Hook Frame
4	310334	Threaded Trunnion
5	11955	Slotted Spring Pin, 1/4 x 1 <sup>3</sup> / <sub>4</sub> "
6	217610	Hex Head Cap Screw, 1/2-13 x 7 <sup>1</sup> / <sub>2</sub>
7	15013	Locknut, 1/2-13
8	217180-BL2	Round Spacer
9	516237	Long Hook Frame
10	217182	Compression Spring
11	513310	Plain Trunnion
12	217181	Compression Spring
13	310336	Forcing Screw
14	215842	Thrust Bearing Washer
15	5133311	Pivot Adapter
-	217186	Warning Decal
-	107300	Parts List

**No. 6492**  
**Engine Preluber Kit**

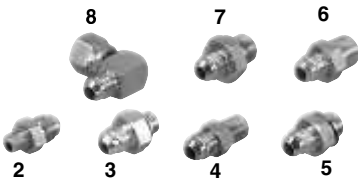

Item No.	Service Part No.	Description
1	509063	Engine Preluber Tank
2	509372	Fitting, .125 NPT
3	509373	Fitting, .25 NPT x .562 JIC
4	219433	Straight Fitting
5	509375	O-ring Fitting, M16 x 1.5
6	509376	O-ring Fitting, M12 x 1.75
7	11628	Straight Fitting
8	205965	90 Degree Elbow Fitting
9	509371	Hand Pump
-	J-36316-A	Universal Storage Pouch
-	511798	Instruction Sheet

**No. 6496**  
**Pitman Arm Puller**

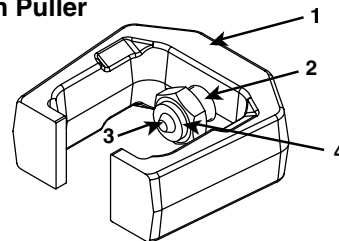

Item No.	Service Part No.	Description
1	518684-1	Puller Frame
2	518684-2	Puller Screw
3	518684-3	Center Swivel
4	211053	Packing O-ring
-	521173	Operating Instruction Sheet



**FOR PRICE INFORMATION  
SEE OTC's MASTER PRICE LIST**

**No. 6503**

**Double Flaring Tool  
(U.S. Customary)**

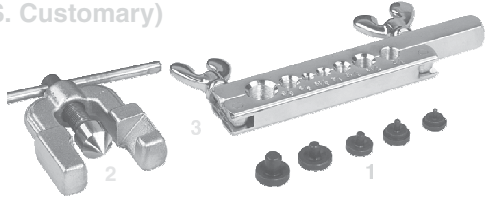

Item No.	Service Part No.	Description
1	6503-1	Adapter Set
2	6503-2	Yoke/Screw Handle Assembly
3	6503-3	Flaring Bar Assembly

**No. 6506**

**Double Flaring Tool  
(Metric)**

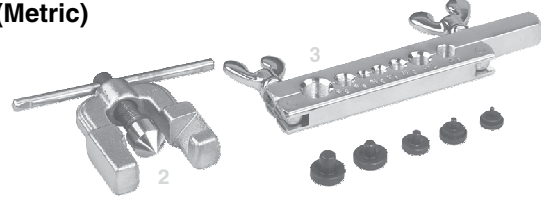

Item No.	Service Part No.	Description
1	6506-1	Adapter Set
2	6506-2	Yoke/Screw Handle Assembly
3	6506-3	Flaring Bar Assembly

**No. 6504**

**ISO Bubble Flaring Tool**

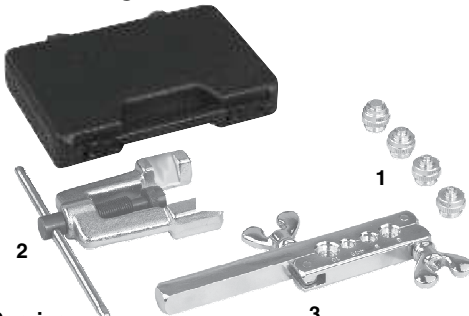

Item No.	Service Part No.	Description
1	6504-1	Adapter Set (4)
2	6504-2	Fuel Line Tool, 5/16" Red
3	6504-3	Fuel Line Tool, 1/4" Black
4	—	Carrying Case (Check for Availability)

**No. 6507**

**Four-Piece Disconnect Tool**

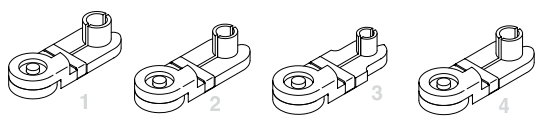

Item No.	Service Part No.	Description
1	518582	Fuel Line Tool, 3/8" Gold
2	518583	Fuel Line Tool, 5/16" Red
3	518584	Fuel Line Tool, 1/4" Black
4	519159	Transmission Oil Line Tool, Blue

**No. 6505**

**Four-Piece Disconnect Tool**



Item No.	Service Part No.	Description
1	511064	Adapter, M10 x 1.5
2	511050	Adapter, M12 x 1.5
3	511051	Adapter, M12 x 1.75

4	511052	Adapter, M14 x 1.5
5	511053	Adapter, M14 x 2.0
6	511054	Adapter, M26 x 1.5
7	Rs-25100	#608 Thrust Bearing -300
8	19780	Hex Nut
9	511057	Forcing Screw
10	511055	Adapter, M16 x 2.0
11	511063	Adapter, 3/4-16
12	511062	Adapter, 5/8-18
13	511061	Adapter, 9/16-18
14	511060	Adapter, 1/2-20
15	511059	Adapter, 7/16-20
16	514008	Carrying Case
—	107205	Instruction Sheet

FOR PRICE INFORMATION  
SEE OTC's MASTER PRICE LIST

## No. 6508

### Master Disconnect Kit

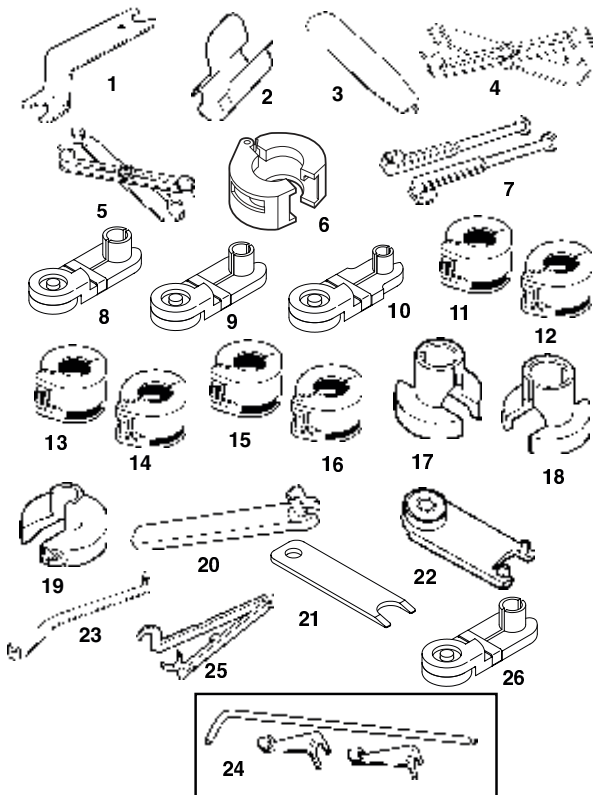

Item No.	Service Part No.	Description
1	440384	GM Hydraulic Clutch Line Tool
2	440486	GM Transmission Oil Cooler Line Tool
3	501153	Toyota A/C Tool
4	511410	Fuel Line Disconnect Tool
5	511413	Fuel Line Tool
6	518092	Heater Hose Tool
7	518158	Fuel Line Tool Set
8	518582	Fuel Line Tool, 3/8" Gold
9	518583	Fuel Line Tool, 5/16" Red
10	518584	Fuel Line Tool, 1/4" Black
11	518896	Fuel Line Tool, 3/8" Yellow
12	518897	A/C Spring Lock Coupling, 5/8" Black
13	518898	A/C Spring Lock Coupling, 1/2" Blue
14	518899	Fuel Line Tool, 1/2" Green
15	518900	A/C Spring Lock Coupling, 3/8" Red
16	518901	A/C Spring Lock Coupling, 3/4" White
17	519067	Fuel Line Tool, 5/16"
18	519068	Fuel Line Tool, 3/8"
19	519151	Quick Disconnect Tool
20	519152	Oil Cooler Line Tool
21	519153	Clutch Coupling Tool
22	519154	Fuel Line Coupling Tool
23	519155	Chrysler Fuel Line Tool
24	519156	Ford Heater Hose Tool Set
25	519157	GM Heater Line Quick Connect Separator
26	519159	Transmission Oil Line Tool, Blue

## No. 6516

### Brake Tool Set



Item No.	Service Part No.	Description
1	519223	Carrying Case
2	519196-4	Brake Spring Pliers
3	519196-3	Brake Spring Removal Tool
4	519196-5	Brake Return Spring Removal Tool
5	519196-2	Brake Adjusting Spoon
6	519196-6	Brake Adjusting Spoon
7	519196-8	Mini Brake Adjusting Spoon
8	519196-7	Brake Spring Removal Tool (3/4" and 13/16" dia. spring)
9	519196-1	Brake Spring Removal Tool (5/8" dia. spring)

## No. 6517

### Nine-Piece Disconnect Set

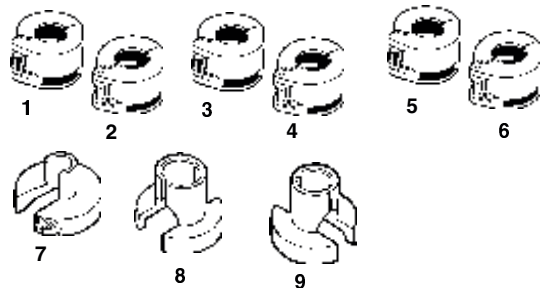

Item No.	Service Part No.	Description
1	518896	Fuel Line Tool, 3/8" Yellow
2	518897	A/C Spring Lock Coupling, 5/8" Black
3	518898	A/C Spring Lock Coupling, 1/2" Blue
4	518899	Fuel Line Tool, 1/2" Green
5	518900	A/C Spring Lock Coupling, 3/8" Red
6	518901	A/C Spring Lock Coupling, 3/4" White
7	519151	Quick Disconnect Tool
8	519068	Fuel Line Tool, 3/8"
9	519067	Fuel Line Tool, 5/16"

### No. 6519

#### Fuel Line Disconnect Tool Set



Item No.	Service Part No.	Description
1	518896	Fuel Line Tool, 3/8" Yellow
2	518899	Fuel Line Tool, 1/2" Green
3	519067	Fuel Line Tool, 5/16"
4	519068	Fuel Line Tool, 3/8"

### No. 6525

#### LeakMaster Evaporative Emissions System Tester

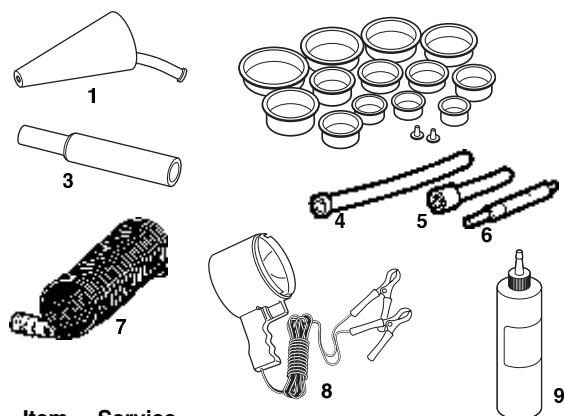

Item No.	Service Part No.	Description
1	CEA-01	Exhaust Cone 3 1/2" dia.
2	CEA-02	Cap Plug Kit
3	CEA-03	Smoke Diffuser Adapter
4	CEA-04	EVAP Service Port Adapter
5	CEA-042	Ford EVAP Service Port Adapter
6	CEA-049	Schrader Valve Removal/Install. Tool
7	CEA-041	Nitrogen Coiled Hose, 25'
8	HS-400AC	Halogen Spotlight
9	P-0716-UV	Smoke-Producing Solution
-	SR00	Water Trap Filter
-	107360	Instruction Manual

### No. 6530

#### Ball Joint Super Set

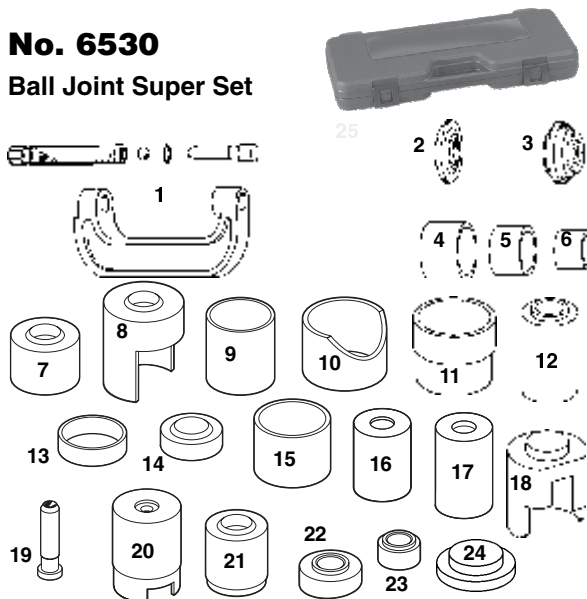

Item No.	Service Part No.	Description
1	7248	C-Frame Press (consists of 1 ea.: forcing screw; 14472 steel ball; 10273 o-ring; 29501 plug; 41925 c-frame)
2	305227	Installing Adapter
3	305228	Removing Adapter
4	29503	Receiving Tube
5	29504	Receiving Tube
6	29505	Receiving Tube
7	39976	Receiving Cup
8	313444	Ball Joint Remover
9	222305	Receiving Tube
10	222306	Receiving Tube
11	314425	Receiving Cup
12	314426	Removing Adapter
13	222304	Receiving Tube
14	204508	Receiving Cup
15	222307	Receiving Tube
16	313969	Installing Cup
17	38355	Installing Cup
18	314427	Receiving Cup
19	314392	Live Center Forcing Screw Plug
20	313967	Remover Cup
21	38354	Receiving Cup
22	313970	Installer
23	313968	Remover
24	314428	Installing Adapter
25	514480	Storage Case (Check for availability)
-	517920	Parts List

### No. 6538

#### A/C Spring Lock Coupling Tools

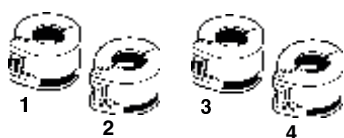

Item No.	Service Part No.	Description
1	518897	A/C Spring Lock Coupling, 5/8" Black
2	518898	A/C Spring Lock Coupling, 1/2" Blue
3	518900	A/C Spring Lock Coupling, 3/8" Red
4	518901	A/C Spring Lock Coupling, 3/4" White

FOR PRICE INFORMATION  
SEE OTC's MASTER PRICE LIST

## No. 6930

### Flange Puller

Item No.	Service Part No.	Description
1	511035	3/4" Flange Puller
2	511036	3/4" Forcing Screw
3	511038	Short Adapter
4	511037	Small Center
5	10059	Hex Head Cap Screws (3) (3/8 - 24 UNF x 3.0)
6	10060	Hex Head Cap Screws (3) (3/8 - 16 UNC x 3.0)

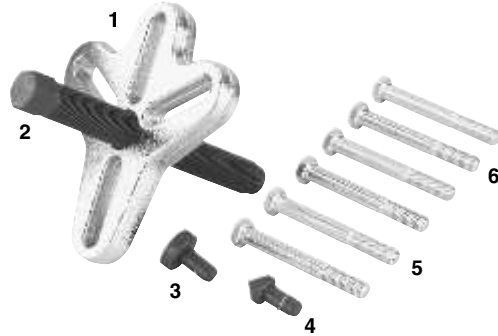

## No. 6985

### Mercedes/BMW Fan Clutch Tool



Item No.	Service Part No.	Description
1	6985-1	Replacement Tool
2	6985-2	Replacement Tool
3	6985-3	Replacement Tool (36 mm)
4	6985-4	Replacement Tool
5	6985-5	Replacement Tool (32 mm)
6	6985-6	Replacement Tool
7	6985-7	Replacement Tool
8	—	Carrying Case (Check for Availability)

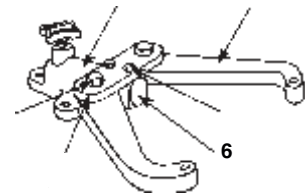

## No. 7024

### Clutch Spring Compressor

Item No.	Service Part No.	Description
1	10209	Hex Nut
2	31784	Jaw
3	12004	Washer
4	302281	Washer
5	31782	Center Tee
6	10578	Round Head Drive Screw, 6 x .25"

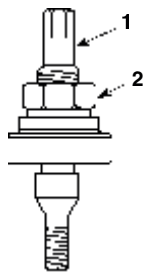
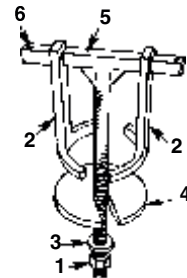

## No. 7028

### Clutch Adjusting Wrench

Item No.	Service Part No.	Description
1	29765	Spacer
2	34856	Wrench
3	14817	Cap Screw
4	210345	Handle Grip

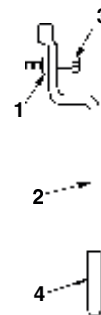

### No. 7029

#### Caster / Camber Wrench

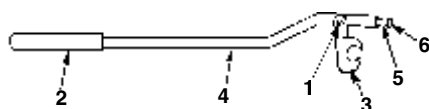

Item No.	Service Part No.	Description
1	11916	Roll Pin
2	210345	Handle Grip
3	23810	Hook
4	41666	Handle
5	29624	Nose
6	12131	Set Screw

### No. 7031A

#### Steering Wheel Lock Plate Remover

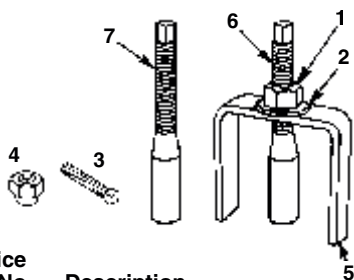

Item No.	Service Part No.	Description
1	10211	Hex Nut, 9/16-12
2	14869	Washer, 9/16" S.A.E.
3	19551	Set Screw
4	204789	Adapter
5	29835	Bridge Bar
6	29836	Special Screw
7	38650	Metric Screw

### No. 7034

#### Disc Brake Pad Spreader

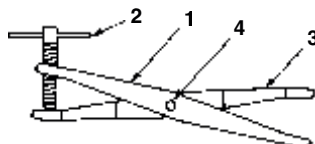

Item No.	Service Part No.	Description
1	35071	Spreader Half, Tapped
2	200108	Screw Assembly
3	35070	Spreader Half, Plain
4	15072	Button Head Cap Screw, 1/4-20 x 5/8"

### No. 7045B

#### Front Coil Spring Compressor

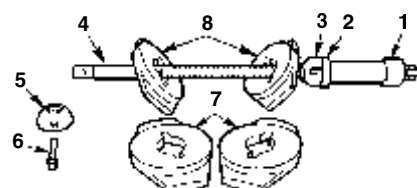

Item No.	Service Part No.	Description
1	37666	Barrel Nut
2	211206	Thrust Bearing
3	311835	Lower Ball
4	49169	Forcing Screw
5	37731	Upper Ball
6	204444	Pin
7	42912-BK2	Support Plate, Large
8	42913-BK2	Support Plate, Small
-	105809	Parts List

### No. 7057

#### U-Joint Service Set

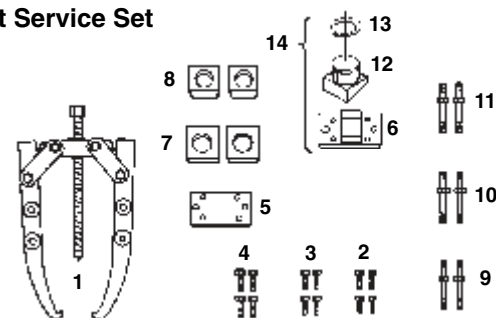

Item No.	Service Part No.	Description
1	1036	Puller (See No. 1036 for separate parts.)
2	16140	Cap Screw, 5/16-24
3	16141	Cap Screw, 3/8-24
4	16142	Cap Screw, 7/16-20
5	36143	Bridge Plate
6	36149	Side Plate (1 only)
7	201456	Journal Cap (1 only)
8	201457	Journal Cap (1 only)
9	201464	Leg, 3/8-24
10	201465	Leg, 5/16-24
11	201466	Leg, 7/16-20
12	201455	Swivel Plug
13	11999	Retaining Ring
14	201533	Side Plate Assembly (consists of Nos. 6, 12, 13)
-	10204	Hex Nut (1 only)
-	201534	Storage Box
-	18745	Storage Box Foam Pad
-	16143	Parts List

FOR PRICE INFORMATION  
SEE OTC's MASTER PRICE LIST

### No. 7069A

#### Heavy-Duty Truck Brake Spring Plier

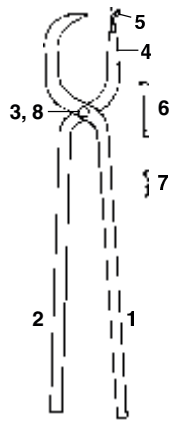

Item No.	Service Part No.	Description
1	42546	Jaw Half
2	40561	Jaw Half
3	12724	Jam Nut
4	11587	Roll Pin
5	202621	Tip
6	204140	Tip
7	18290	Hair Pin
8	219500	Cap Screw

### No. 7070A

#### Truck Transmission Bearing Service Set

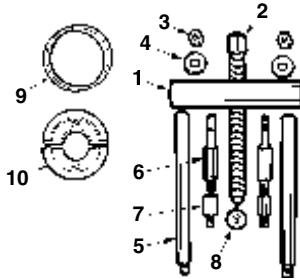

Item No.	Service Part No.	Description
1	42542	Cross Block
2	34703	Forcing Screw
3	10208	Hex Nut, 1/2-13 (1 only)
4	12004	Washer, 1/2" S.A.E. (1 only)
5	310553	Long Leg (1 only)
6	310552	Short Leg (1 only)
7	202893	Adapter (1 only)
8	202916	Step Plate
9	202894	Sleeve
10	48387	Collet Half
-	105596	Parts List

### No. 7071

#### Differential Housing Spreader

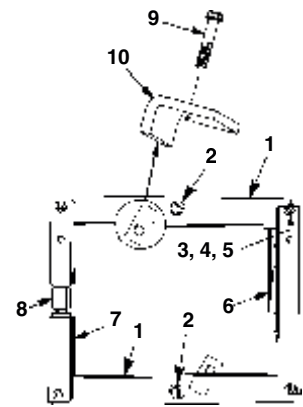

Item No.	Service Part No.	Description
1	37050	Bolster
2	203006	Bearing Pin
3	12004	Washer, 17/32" I.D.
4	10208	Hex Nut, 1/2-13
5	12560	Socket Head Cap Screw, 1/2-13 x 2 1/2"
6	37047	Leg Weldment
7	37051	Spreader Assembly (includes 37048 Clevis; 37049 Tapped Clevis; 16209 Thrust Bearing Race; 11902 Retaining Ring.)
8	203005	Clevis Screw (included with Spreader)
9	10057	Cap Screw, 3/8-16 x 2"
10	207683	Bracket
-	104672	Parts List

### No. 7075

#### Transmission Output Shaft End Yoke Remover

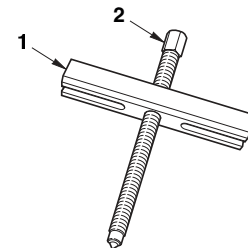

Item No.	Service Part No.	Description
1	42542	Cross Block
2	34703	Forcing Screw

**No. 7082B §**  
Automotive Piston Pin Remover / Installer Set

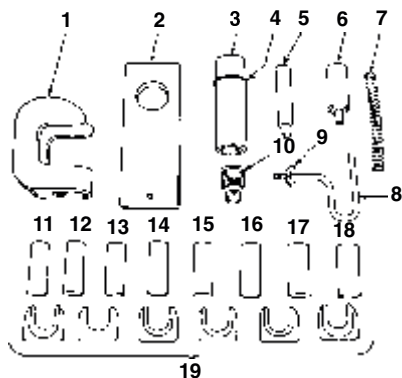

Item No.	Service Part No.	Description
1	302186	Anvil
2	17929	Base
3	17931-B	Tube Guide
4	17945	Retaining Ring
5	17935	Driver
6	17932-B	Body Guide
7	17934	Spring
8	302224	Rear Support
9	10589	Wing Nut
10	17930-B	Threaded Plug
11	17940	Pin Guide
12	17936	Pin Guide
13	17937	Pin Guide
14	17938	Pin Guide
15	17939	Pin Guide
16	17941	Pin Guide
17	17942	Pin Guide
18	18729	Pin Guide
19	39889	Insert 1
19	39890	Insert 2
19	39888	Insert 3
19	39886	Insert 4
19	39887	Insert 5
19	39922	Insert 6
-	60835	Plastic Case
-	104609	Parts List

**No. 7084**  
Transmission Input Shaft Tool

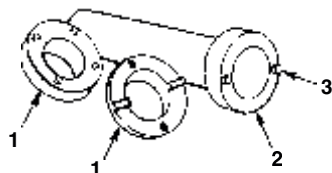

Item No.	Service Part No.	Description
1	43199	Spanner Wrench Adapter
2	43195	Spanner Wrench
3	13720	Groove Pin

**No. 7085**  
Dust Boot Clamp Installer

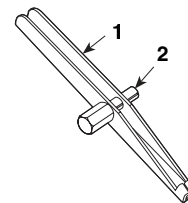

Item No.	Service Part No.	Description
1	18864	Dust Boot Clamp Installer
2	220040	Pin
-	18865	Instruction Sheet

**No. 7091**  
Ford Caster / Camber Alignment Tool

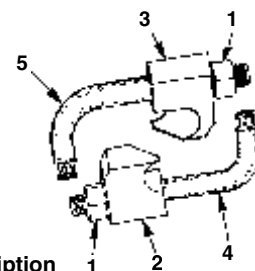

Item No.	Service Part No.	Description
1	10208	Hex Nut
2	43359	Left Body
3	43360	Right Body
4	38532	Hook
5	38533	Hook

**No. 7104**  
GM Power Steering Pump Pulley Removal Screw

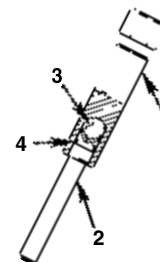

Item No.	Service Part No.	Description
1	27445	Forcing Screw
2	310901	Long Nose Cone
3	10378	Steel Ball
4	10266	O-ring

FOR PRICE INFORMATION  
SEE OTC's MASTER PRICE LIST

### No. 7106

#### Cylinder Liner Height Gauge w/ Hold-Down Bar

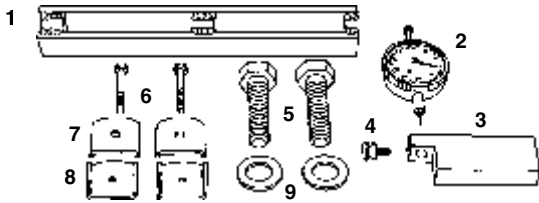

Item No.	Service Part No.	Description
1	39431	Clamping Bar
2	205655	Dial Indicator
3	39432	Gauge Bar
4	205715	Thumb Screw
5	205702	Hex Head Cap Screw, <sup>11</sup> / <sub>16</sub> -16 UN-2A
6	10024	Hex Head Cap Screw, <sup>1</sup> / <sub>4</sub> -20 x 1 <sup>3</sup> / <sub>4</sub> "
7	205653	Drilled Spacer
8	205652	Tapped Spacer
9	24826	Washer
-	307382	Carrying Case
-	43513	Carrying Case Foam Insert
-	102370	Parts List

### No. 7108

#### Transmission Timing Block Tool

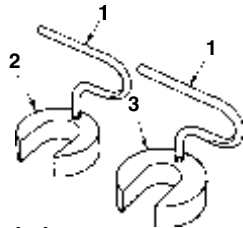

Item No.	Service Part No.	Description
1	302224	Rear Support
2	7108-1	Transmission Timing Block Tool (includes #302224)
3	7108-2	Transmission Timing Block Tool (includes #302224)

### No. 7109

#### Transmission Timing Block Tool

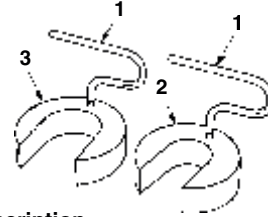

Item No.	Service Part No.	Description
1	302224	Rear Support
2	7109-1	Transmission Timing Block Tool (includes #302224)
3	7109-2	Transmission Timing Block Tool (includes #302224)

### No. 7117

#### Caterpillar Fuel Injector Nozzle Puller

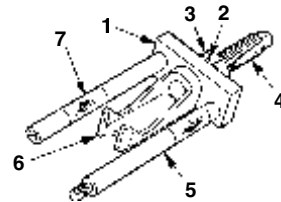

Item No.	Service Part No.	Description
1	206508	Plate
2	14597	Bearing Race
3	10213	Hex Nut
4	39992	Screw
5	39989	Leg
6	39993	Puller Jaw
7	39990	Leg

### No. 7118

#### Transmission Adapter Kit

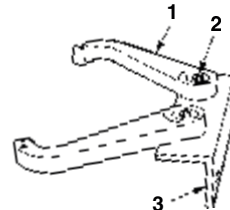

Item No.	Service Part No.	Description
1	34310-BL2	Arm
2	10083	Hex Head Cap Screw, <sup>1</sup> / <sub>2</sub> -13 x 1 <sup>1</sup> / <sub>2</sub> "
3	43883	Angle
-	10099	Hex Head Cap Screw, <sup>5</sup> / <sub>8</sub> -11 x 1 <sup>1</sup> / <sub>2</sub> "
-	10208	Hex Nut, <sup>1</sup> / <sub>2</sub> -13
-	102383	Operating Instructions



**No. 7119**  
Compressor Drive Gear Coupling Puller

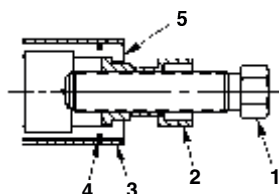

Item No.	Service Part No.	Description
1	39972	Forcing Screw
2	39973	Nut
3	206420	Tube
4	15125	O-ring
5	39971	Collet Half

**No. 7122R**  
Ford Lock Pin Remover

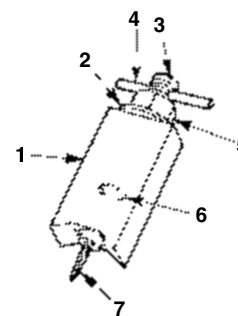

Item No.	Service Part No.	Description
1	302767	Bridge
2	10257	Washer
3	302766	Forcing Screw
4	13554	Slotted Spring Pin
5	10203	Hex Nut
6	18761	Retaining Ring
7	37907	Remover Tip

**No. 7120A**  
Drive Pulley Installer

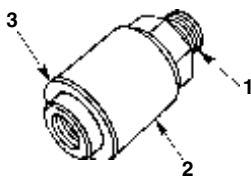

Item No.	Service Part No.	Description
1	39978	Forcing Screw
2	39979	Nut
3	206431	Thrust Bearing Washer

**No. 7134 §**  
C.V. Joint Separator

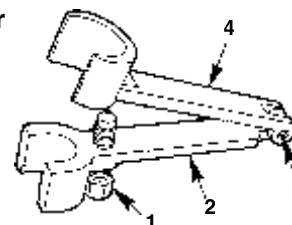

Item No.	Service Part No.	Description
1	205422	Screw
2	43996	Spreader Half
3	11916	Roll Pin
4	39725	Spreader Half

**No. 7120B**  
Drive Pulley Remover

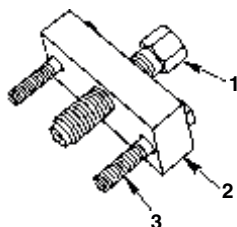

Item No.	Service Part No.	Description
1	24426	Screw
2	39975	Cross Block
3	206422	Hex Head Cap Screw

**No. 7135A**  
FWD Front Hub Installer

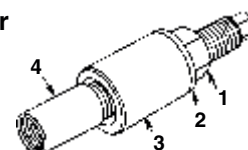

Item No.	Service Part No.	Description
1	12121	Hex Nut, 3/4-10
2	12330	Washer
3	207968	Sleeve
4	303374	Screw

**No. 7121**  
Fuel Injector Nozzle Puller

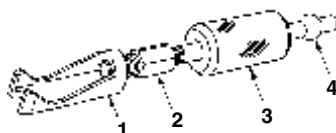

Item No.	Service Part No.	Description
1	39993	Puller Jaw
2	206437	Reducing Adapter
3	208911	Hammer
4	208912	Shank

FOR PRICE INFORMATION  
SEE OTC's MASTER PRICE LIST

**No. 7136**  
Bearing Cup Remover

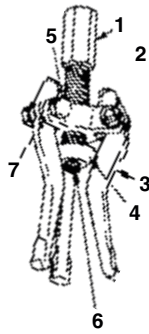

Item No.	Service Part No.	Description
1	203662	Forcing Screw
2	10384	Hex Jam Nut
3	37554	Puller Jaw
4	27299	Cone Expander
5	22021	Hex Head Cap Screw
6	13334	Shoulder Screw
7	24544	Puller Head

**No. 7180**  
Universal Bearing Cup  
Installer

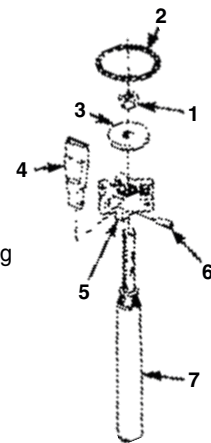

Item No.	Service Part No.	Description
1	10213	Hex Nut, 5/8-18
2	207561	Extension Spring
3	210583	Expander
4	52038	Jaw
5	305130	3-Way Head
6	209624	Pin
7	305129	Handle
-	104916	Parts List

**No. 7148**  
Propane  
Enrichment Kit

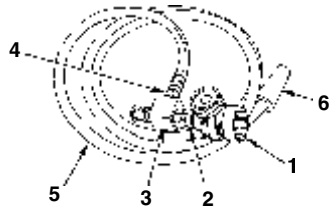

Item No.	Service Part No.	Description
1	15912	Tank Valve
2	310831	Straight Adapter
3	15914	Poppet Valve
4	15913	Barbed Fitting, 1/8 NPTM-1/4
5	15028	Plastic Tubing
6	201186	Plug

**No. 7185**  
Power Steering Pump /  
Alternator Pulley Remover

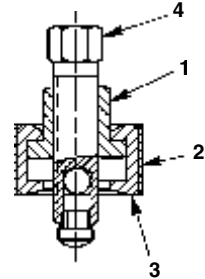

Item No.	Service Part No.	Description
1	304107	Nut
2	208703	Sleeve
3	304108	Collet Half
4	27445	Forcing Screw

**No. 7155A**  
Mack Fuel Injector  
Nozzle Puller

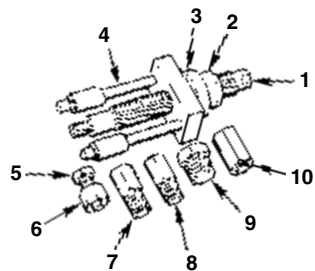

Item No.	Service Part No.	Description
1	303903	Forcing Screw, M10 x 1.0mm
2	10216	Nut, 3/4-10
3	12702	Thrust Bearing
4	208403	Bridge
5	10047	Cap Screw, 3/4-10
6	208642	Adapter
7	208533	Adapter, M14 x .5mm
8	208534	Adapter, 1/2-20
9	208535	Adapter, M20 x .75mm
10	215751	Adapter, M14 x 1.5mm
-	14701	Plastic Case
-	104721	Parts List

**No. 7206**  
Multi-Purpose  
Strap Wrench

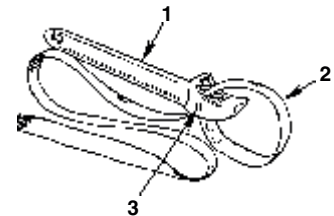

Item No.	Service Part No.	Description
1	45742	Handle
2	305085	Strap
3	210749	Slotted Spring Pin

**No. 7208A**  
Front Hub Installer  
and Puller

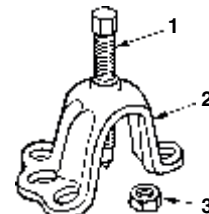

Item No.	Service Part No.	Description
1	24833	Forcing Screw
2	520968	Front Hub Remover
3	10394	Jam Nut

**No. 7209**  
GM Power Steering Pump Pulley Installer

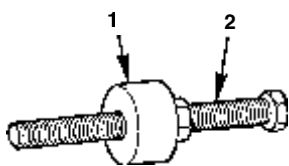

Item No.	Service Part No.	Description
1	312346	Nut
2	217946	Cap Screw, 3/8-16 x 4"

**No. 7236**  
Spring Lock Coupling Adapter

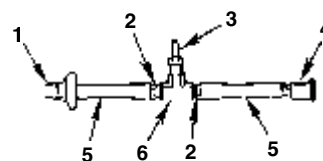

Item No.	Service Part No.	Description
1	212769	Spring Lock Coupler, Male
2	212802	Barbed Hose Fitting
3	206877	Coupler Plug
4	212755	Spring Lock Coupler, Female
5	212801	Hose (2 pcs., 2 1/4" Long)
6	12165	Pipe Tee

**No. 7211**  
Gauge & Hose Assembly

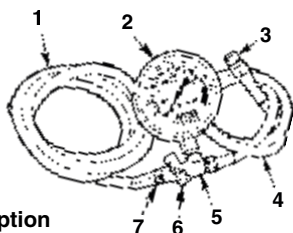

Item No.	Service Part No.	Description
1	15028	Flexible Tubing
2	309124	0-100 PSI Pressure Gauge
3	206878	Coupler Socket
4	211398	Pressure Hose
5	19463	Tee Fitting
6	208389	Valve
7	15913	Barbed Hose Fitting

**No. 7245**  
Steering Wheel Puller

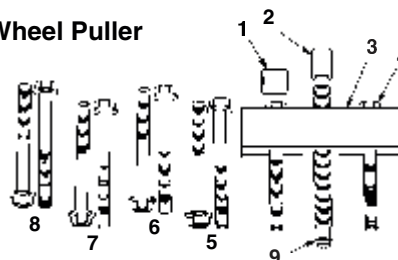

Item No.	Service Part No.	Description
1	209802	Collar
2	304828	Forcing Screw
3	304855	Cross Block
4	209950	Hex Flange Head Screw, 3/8-16 x 3 1/2" (1 only, 2 reqd.)
5	209951	Hex Flange Head Screw, 5/16-18 x 3 1/2" (1 only, 2 reqd.)
6	209952	Hex Flange Head Screw, 5/16-24 x 3 1/2" (1 only, 2 reqd.)
7	209953	Hex Flange Head Screw, M8-1.25 x 90mm (1 only, 2 reqd.)
8	218177	Hex Flange Head Screw, 5/16-18 x 4" (1 only, 2 reqd.)
9	209803	O-ring

**No. 7213**  
In-Line Adapter

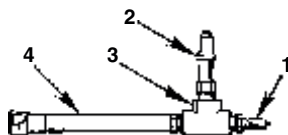

Item No.	Service Part No.	Description
1	206877	Coupler Plug
2	440519	Fitting
3	12165	Pipe Tee
4	212155	Hose with Fittings

**No. 7215**  
Exhaust Back Pressure Gauge

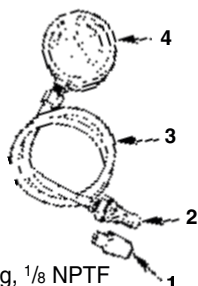

Item No.	Service Part No.	Description
1	211474	Rubber Plug
2	212339	Manifold Adapter
3	306508	Hose
4	306509	Pressure Gauge
-	214675	Barbed Hose Fitting, 1/8 NPTF
-	14680	90° Street Elbow
-	105909	Instruction Sheet

**No. 7246**  
Adjustable Spanner Wrench

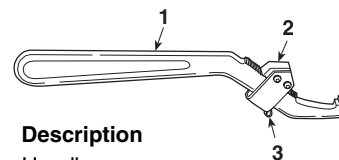

Item No.	Service Part No.	Description
1	31634	Handle
2	23750	Adjusting Block
3	23753	Check Spring

FOR PRICE INFORMATION  
SEE OTC's MASTER PRICE LIST

**No. 7248  
7249**

**Ball Joint  
Service Tools**

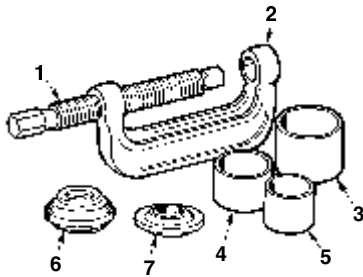

Item No.	Service Part No.	Description
1	222395	Forcing Screw Assembly (consists of 37703 Forcing Screw, 29501 Plug, 14472 5/8" Dia. Steel Ball, 10273 O-ring.)
2	41925	C-Frame
3	29503	Receiving Tube, 3" O.D., 2 3/4" I.D.
4	29504	Receiving Tube, 2 1/2" O.D., 2 1/4" I.D.
5	29505	Receiving Tube, 2" O.D., 1 3/4" I.D.
6	305228	Removing Adapter
7	305227	Installing Adapter
-	104950	Parts List

**No. 7262**

**GM Power Steering Pump  
Pulley Remover**

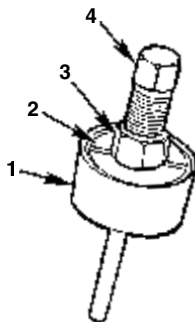

Item No.	Service Part No.	Description
1	208703	Sleeve
2	304108	Collet Half
3	304107	Nut
4	27445	Forcing Screw

**No. 7272**

**EFI Quick Disconnect  
Fitting**

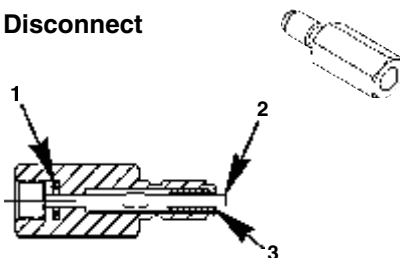

Item No.	Service Part No.	Description
1	15023	O-ring
2	213261	Activator Pin
3	16832	Slotted Spring Pin

**No. 7273**

**Pressure Adapter**

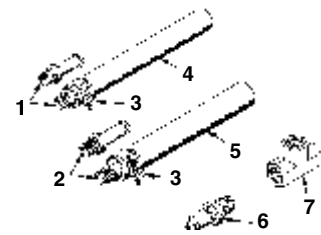

Item No.	Service Part No.	Description
1	213721	Carburetor Fuel Fitting (5/16" Hose)
2	213722	Carburetor Fuel Fitting (3/8" Hose)
3	213720	Hose Clamp
4	211473	Hose, 5/16" I.D., 4" Long
5	213719	Hose, 3/8" I.D., 4" Long
6	206877	Coupler Plug
7	12165	Tee Fitting (1/8 NPTF)
-	106177	Parts List

**No. 7292A  
7293A**

**Quick Disconnect  
Fitting**

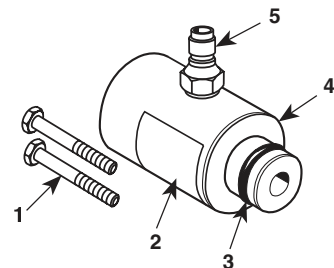

Item No.	Service Part No.	Description
1	210420	Metric Hex Head Cap Screw
2	210192	Warning Decal
3	18974	O-ring for 7292A
3	18996	O-ring for 7293A
4	48767	Fuel Pressure Test Adapter for 7292A
4	48768	Fuel Pressure Test Adapter for 7293A
5	206877	Coupler Plug
-	105927	Parts List

**No. 7294**

**MacPherson Strut Spring Hook Compressor**

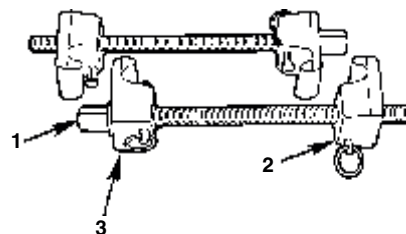

Item No.	Service Part No.	Description
1	7294-3	Forcing Screw and Thrust Bearing Washer
2	7294-1	Threaded Hook and Clevis Pin
3	7294-2	Hook and Clevis Pin

**No. 7307  
7308**

**Adjustable Hook Spanner Wrench**



Item No.	Service Part No.	Description
1	38012	Forged Handle
2	44502	Jaw
3	41617	Jaw for 7308
4	200017	Pivot Pin Body
5	200018	Pivot Pin Screw
6	200019	Pivot Pin Washer

**No. 7311  
Pitman Arm Puller**

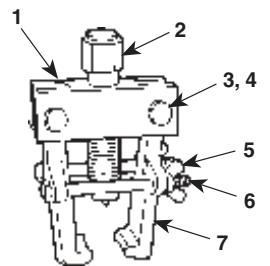

Item No.	Service Part No.	Description
1	201110	Block
2	23609	Screw
3	10388	Hex Jam Nut
4	22029	Hex Head Cap Screw
5	10590	Wing Nut, 5/16-18
6	10043	Hex Head Cap Screw
7	38430	Puller Jaw

**No. 7309**

**Heavy-Duty Adjustable Spanner**

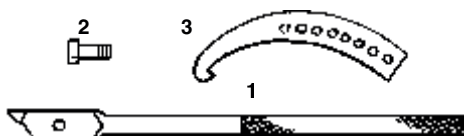

Item No.	Service Part No.	Description
1	37813	Forged Handle
2	208602	Cap Screw
3	41617	Jaw

**No. 7314  
Pitman Arm Puller**

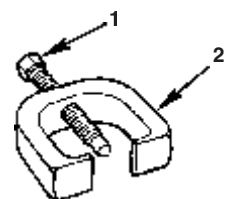

Item No.	Service Part No.	Description
1	24833	Forcing Screw
2	305972	Puller

**No. 7310  
Pitman Arm Puller**

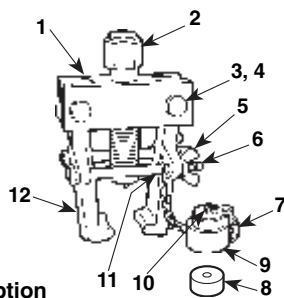

Item No.	Service Part No.	Description
1	39131	Cross Block
2	26619	Forcing Screw
3	10069	Hex Head Cap Screw
4	10388	Hex Jam Nut
5	10590	Wing Nut, 5/16-18
6	13338	Hex Head Cap Screw
7	10473	Sash Chain
8	205862	Shaft Protector
9	205863	Shaft Protector
10	10573	Cotter Pin
11	10462	Hog Ring #3
12	208910	Puller Jaw

**No. 7315  
Universal Tie Rod  
End Remover**

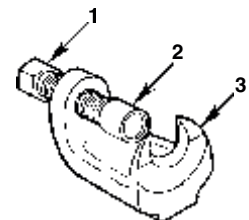

Item No.	Service Part No.	Description
1	304238	Forcing Screw
2	209390	Cap
3	45495	Body
-	10300	O-ring

FOR PRICE INFORMATION  
SEE OTC's MASTER PRICE LIST

**No. 7318  
7319**  
Pilot Bearing Puller

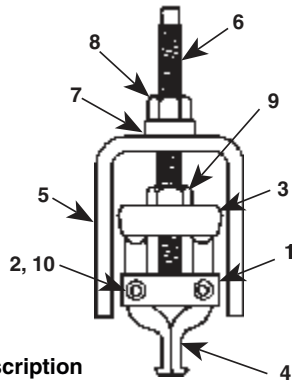

Item No.	Service Part No.	Description
1	27044	Cross Block
2	10014	Cap Screw
3	201952	Adjusting Yoke
4	29185	Jaw for 7318, 1/2" to 1 1/2" Spread
4	29189	Jaw for 7319, 7/8" to 2" Spread
5	35033	Puller Bridge
6	200063	Forcing Screw
7	24839	Washer
8	10210	Hex Nut, 1/2-20
9	10390	Hex Jam Nut, 1/2"
10	10382	Hex Jam Nut

**No. 7393**  
Gear & Pulley Puller

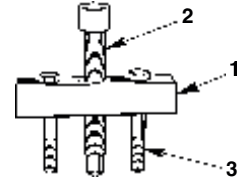

Item No.	Service Part No.	Description
1	26603	Cross Block
2	24833	Forcing Screw, 5 1/2"
3	10060	Cap Screw, 3/8 NC (1 only)

**No. 7394**  
Universal Hub Puller

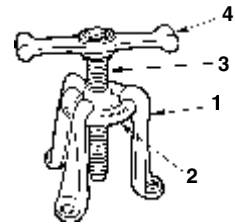

Item No.	Service Part No.	Description
1	32937	Puller Leg
2	32939	Center Hub
3	32940	Forcing Screw, 1-14 x 9" Long
4	32942	Striking Wrench

**No. 7374**  
Slide Hammer Rear Axle Puller

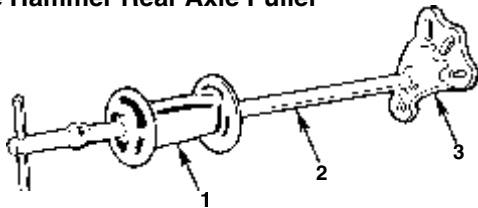

Item No.	Service Part No.	Description
1	34331	Hammer
2	208627	Shank and Tee Bar Assembly
3	7372	Pulling Adapter Plate

**No. 7400  
7401**  
Ratcheting Chain Wrench

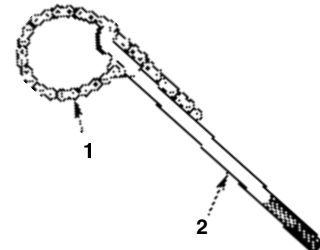

Item No.	Service Part No.	Description
1	13905	16" Chain for 7400
1	11608	24" Chain for 7401
2	51033	Handle for 7400
2	33118	Handle for 7401
-	17154	Handle Grip for 7400

**No. 7392**  
Gear & Pulley Puller



Item No.	Service Part No.	Description
1	26603	Cross Block
2	24832	Forcing Screw, 13"
3	10060	Cap Screw, 3/8 NC (1 only, 2 reqd.)

### No. 7402 7402M

#### Universal Outside Thread Chaser

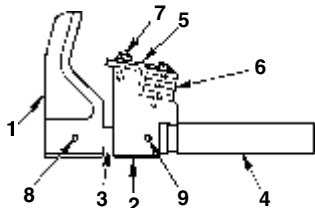

Item No.	Service Part No.	Description
1	46107	V-Pad
2	52518	Post
3	25512	Screw
4	25509	Handle
5	25510	Strap
6	8090	8-10-12-14 Pitch Die for 7402
6	8091	16-18-20-24 Pitch Die for 7402
6	8092	11-11½ Pitch Die for 7402
6	8093	4-5 Pitch Die for 7402
6	8094	6-7 Pitch Die for 7402
6	8095	7½-9 Pitch Die for 7402
6	8096	1 mm–1.75 mm Pitch Die for 7402M
6	8097	2 mm–3.5 mm Pitch Die for 7402M
6	8098	4 mm Pitch Die for 7402M
7	10027	Hex Head Cap Screw
8	10585	Roll Pin, 1"
9	12828	Roll Pin, ¼ x ⅜

### No. 7413

#### Ford / Chrysler Heater Hose Disconnect Tool



Item No.	Service Part No.	Description
1	7413-1	5/8" Heater Hose Connection Remover
2	7413-2	3/4" Heater Hose Connection Remover
3	7413-3	Handle

### No. 7426

#### Quick Disconnect Banjo Fitting

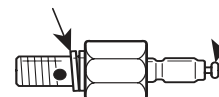

Item No.	Service Part No.	Description
1	215278	Sealing Ring Washer
2	215806	Schrader Valve Core

### No. 7403

#### Steering Wheel / Pulley / Flywheel Puller

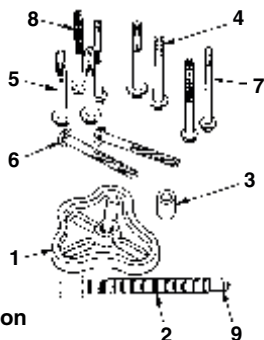

Item No.	Service Part No.	Description
1	208170	Flange
2	304828	Forcing Screw
3	209802	Collar
4	209950	Hex Flange Head Cap Screw 3/8–16 x 3½
5	209951	Hex Flange Head Cap Screw 5/16–18 x 3½
6	209952	Hex Flange Head Cap Screw 5/16–24 x 3½
7	218177	Hex Flange Head Cap Screw 5/16–18 x 4
8	209953	Hex Flange Head Cap Screw M8 x 1.25 x 90mm
9	209803	O-ring

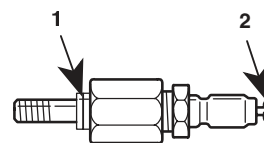

### No. 7428

#### Quick Disconnect Banjo Fitting

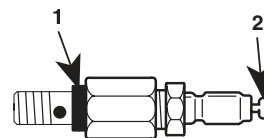

Item No.	Service Part No.	Description
1	215282	Sealing Ring Washer
2	215806	Schrader Valve Core

FOR PRICE INFORMATION  
SEE OTC's MASTER PRICE LIST

**No. 7429**

**Quick Disconnect Banjo Fitting**

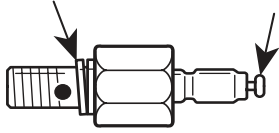

Item No.	Service Part No.	Description
1	215278	Sealing Ring Washer
2	215806	Shrader Valve Core

**No. 7430**

**Quick Disconnect 90° Elbow Fitting**

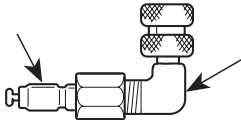

Item No.	Service Part No.	Description
1	212156	Quick-Plug Coupler
2	215284	Elbow Adapter Fitting, 1/8 NPT

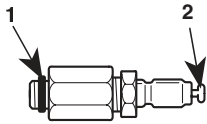

**No. 7436§**

**Quick Disconnect Fitting**



Item No.	Service Part No.	Description
1	215742	O-ring
2	215806	Shrader Valve Core

**No. 7437**

**Quick Disconnect Fitting**

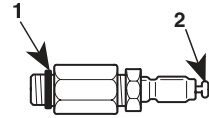

Item No.	Service Part No.	Description
1	19088	O-ring
2	215806	Shrader Valve Core

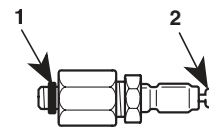

**No. 7440**

**CIS Fuel Line Adapter**

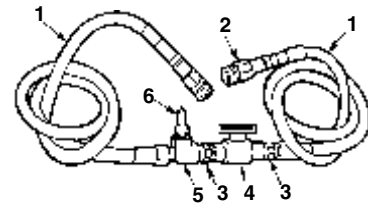

Item No.	Service Part No.	Description
1	211398	Pressure Hose
2	206878	Coupler Socket
3	12169	Hex Nipple, 1/8 NPT
4	214114	Plug Valve
5	19463	Tee Fitting
6	206877	Coupler Plug

**No. 7441  
7442  
7443**

**Banjo Fitting**

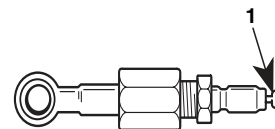

Item No.	Service Part No.	Description
1	215806	Shrader Valve Core



**No. 7448**  
Canister-Type Fuel Injector Cleaner

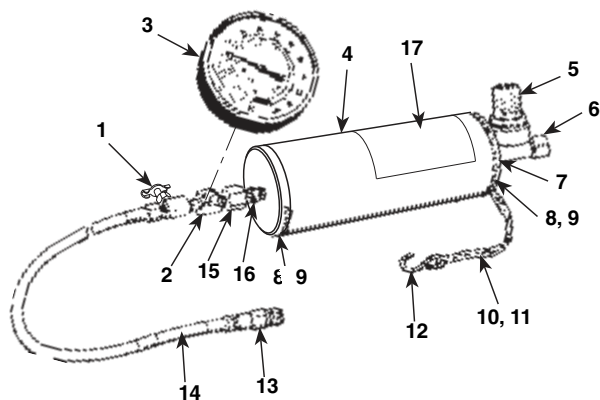

Item No.	Service Part No.	Description
1	208389	Valve
2	19463	Tee Fitting
3	313575	Pressure Gauge (0-100 PSI / 0-7 BAR)
4	47955	Cylinder Body
5	213299	Air Regulator
6	15373	90° Elbow Fitting
7	16494	Straight Fitting, 1/4 NPTF
8	309796	Cylinder Cap (1 only, 2 reqd.)
9	213209	O-ring (1 only, 2 reqd.)
10	10473	Sash Chain, 6 7/8" long
11	213876	Split Ring
12	15665	"S" Hook
13	206878	Coupler Socket
14	306905	Hose (1/8 NPTF x 6' long) with Fitting
15	17022	Straight Fitting
16	216297	Check Valve
17	313576	Decal
-	107340	Parts List
-	106103	Instruction Manual

**No. 7454**  
Navistar® Fuel Injector Nozzle Puller

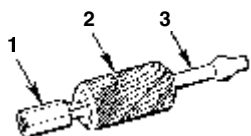

Item No.	Service Part No.	Description
1	215844	Adapter
2	208911	Hammer
3	208912	Shank

**No. 7455**  
Fuel Injector Nozzle Puller / Installer

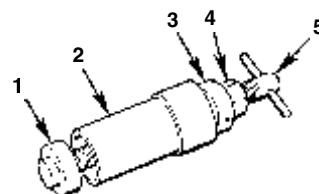

Item No.	Service Part No.	Description
1	215752	Installation Gauge
2	215753	Tube
3	15427	Bearing
4	10213	Nut
5	309144	Forcing Screw
-	14701	Plastic Case

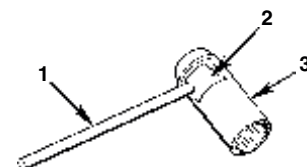

**No. 7461**  
Fuel Injection Pump Rotating Tool

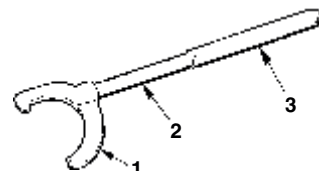

Item No.	Service Part No.	Description
1	208399	Jaw
2	208398	Handle
3	11945	Handle Grip

**No. 7462**  
Hydraulic Brake Spring Remover / Installer



Item No.	Service Part No.	Description
1	309350	Handle
2	215922	Plate

FOR PRICE INFORMATION  
SEE OTC's MASTER PRICE LIST

## No. 7464

### Chrysler Crankshaft Pulley Remover / Installer

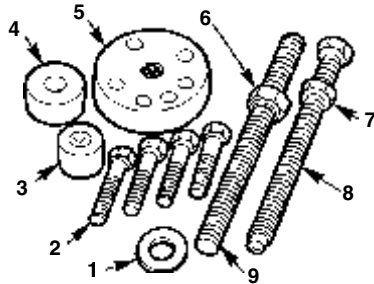

Item No.	Service Part No.	Description
1	15513	Thrust Race
2	211993	Cap Screw, M8 x 1.25 x 35 mm (1 only)
3	217294	Shaft Protector
4	217295	Drive Plate
5	310430	Puller Plate
6	18911	Hex Nut
7	19412	Hex Nut
8	217293	Special Hex Cap Screw
9	216232	Threaded Rod

## No. 7470

### Cummins Diesel Injector Timing Tool Set

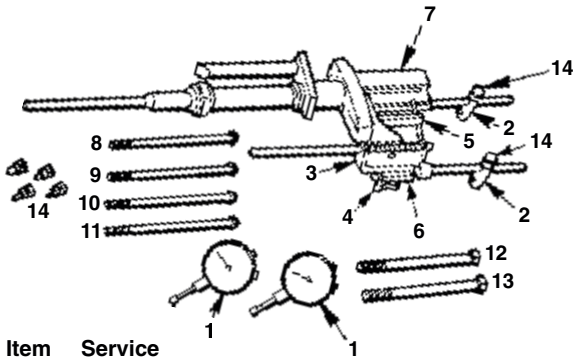

Item No.	Service Part No.	Description
1	308171	Dial Indicator Gauge (1 only)
2	214633	Dial Indicator Support (1 only)
3	47116	Push Tube Plunger Bracket
4	214632	Push Tube Plunger Knob
5	308394	Locking Nut
6	53091	Center Support Bracket
7	61798	Bracket
8	215342	Cap Screw, M8 x 1.25 x 150 mm
9	215343	Cap Screw, $\frac{5}{16}$ -18 x 6"
10	215344	Cap Screw, $\frac{3}{8}$ -16 x 6"
11	215345	Cap Screw, $\frac{3}{8}$ -24 x 6"
12	215346	Cap Screw, $\frac{1}{2}$ -13 x 6"
13	215347	Cap Screw, $\frac{1}{2}$ -20 x 6"
14	18912	Thumb Screw (1 only)
-	61744	Storage Case
-	105277	Parts List

## No. 7472

### Conversion Adapter

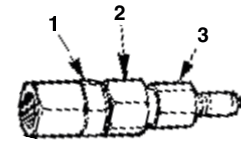

Item No.	Service Part No.	Description
1	218214	Straight Fitting
2	210416	Straight Fitting Coupler
3	212156	Quick-Plug Coupler

## No. 7488A

### Universal Brake Pressure Test Kit

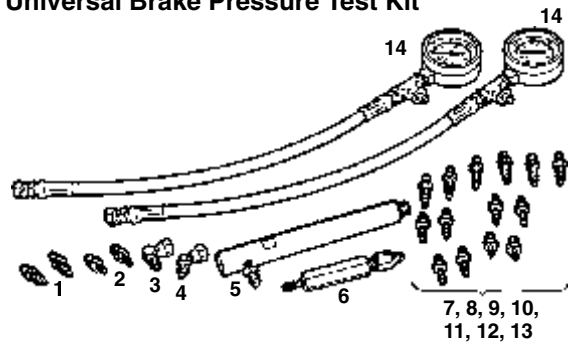

Item No.	Service Part No.	Description
1	48854	Straight Fitting ( $\frac{7}{16}$ -20 UNF 37° Flare to $\frac{7}{16}$ -20 UNF 45° Flare)
2	48855	Straight Fitting ( $\frac{7}{16}$ -20 UNF 37° Flare to M7 x 1.0 45° Flare)
3	16867	90° Elbow Fitting (37° Flare Male to 37° Flare Female Swivel)
4	16868	45° Elbow Fitting (37° Flare Male to 37° Flare Female Swivel)
5	311102	Teves Adapter
6	311096	Anti-Lock Pressure Adapter
7	48678	Straight Fitting ( $\frac{7}{16}$ -20 UNF 37° Flare to M8 x 1.25 37° Flare)
8	48674	Straight Fitting ( $\frac{7}{16}$ -20 UNF 37° Flare to $\frac{1}{4}$ -28 UNF 37° Flare)
9	48676	Straight Fitting ( $\frac{7}{16}$ -20 UNF 37° Flare to $\frac{5}{16}$ -24 UNF 37° Flare)
10	48675	Straight Fitting ( $\frac{7}{16}$ -20 UNF 37° Flare to $\frac{3}{8}$ -24 UNF 37° Flare)
11	48673	Straight Fitting ( $\frac{7}{16}$ -20 UNF 37° Flare to $\frac{7}{16}$ -24 UNS 37° Flare)
12	48679	Bleeder Adapter ( $\frac{7}{16}$ -20 UNF 37° Flare to M10 x 1.0 45° Flare)
13	48677	Straight Fitting ( $\frac{7}{16}$ -20 UNF 37° Flare to M10 x 1.5 37° Flare)
14	7486	Gauge Assembly, 0-3000 PSI (1 only)
-	105719	Parts List
-	105760	Technician Reference Guide

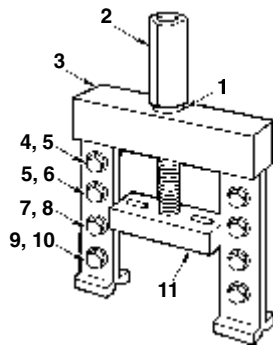

**No. 7504**  
Inner Tie Rod  
Crimper Tool

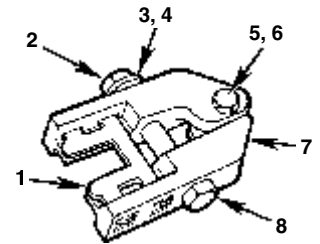

Item No.	Service Part No.	Description
1	310429	Guide Plate
2	215654	Nut, 1/2-13 UNC, Grade 8
3	15513	Thrust Bearing Washer
4	217285	Hex Washer
5	10055	Cap Screw, 3/8-16 x 1 1/2
6	12013	Locknut, 3/8-16
7	48305	Crimper
8	18213	Cap Screw, 1/2-13 x 3 1/2
-	105584	Instruction Sheet

**No. 7491C**  
GM Upper Control Arm  
Knock-Out Tool

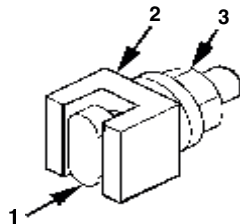

Item No.	Service Part No.	Description
1	506142	Forcing Screw
2	506143	Bridge
3	506141	Spherical Flange Nut

**No. 7505**  
Inner Tie Rod Tool

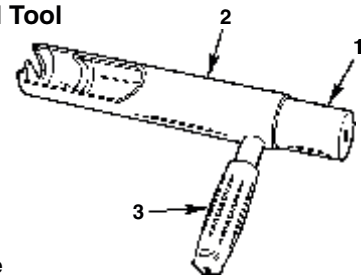

Item No.	Service Part No.	Description
1	48309	Inside Tube Wrench
2	48310	Outside Tube Wrench
3	11390	Handle Grip
-	105585	Instruction Sheet

**No. 7503**  
Outer Tie Rod  
Remover

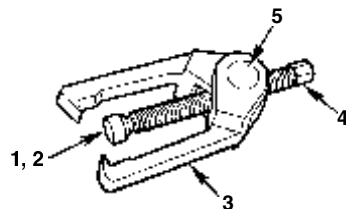

Item No.	Service Part No.	Description
1	310484	Forcing Screw Tip
2	215219	Retaining Ring (not shown)
3	48332	Tie Rod Remover Jaw
4	308884	Forcing Screw
5	217325	Pivot Pin

**No. 7506**  
Front Wheel Drive  
Service Set

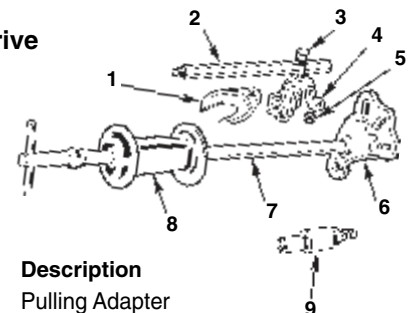

Item No.	Service Part No.	Description
1	306284	Pulling Adapter
2	7508	Extension
3	24833	Forcing Screw
4	47407	Puller Head
5	10394	Nut, 5/8-18
6	7372	Pulling Adapter Plate
7	208627	Shank and Tee Bar Assembly
8	34331	Hammer
9	7135A	Front Hub Installer

FOR PRICE INFORMATION  
SEE OTC's MASTER PRICE LIST

**No. 7507  
7509**

**Inner C.V. Joint Puller**

Item No.	Service Part No.	Description
1	306284	Puller Adapter
2	10394	Jam Nut, 5/8-18
3	208627	Shank and Tee Bar Assembly (7509)
4	34331	5 Lb. Hammer (7509)

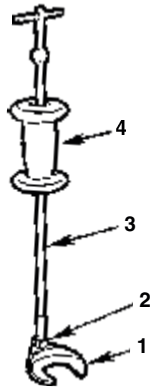

**No. 7535**

**Subaru Front Axle Shaft Installer**

Item No.	Service Part No.	Description
1	216878	Sleeve
2	309750	Forcing Screw
3	12330	Washer
4	12121	Hex Nut, 3/4-10 UNC

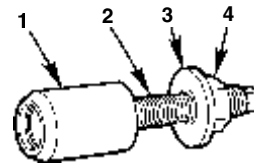

**No. 7515§**

**Roto and Bar Mount Vise**

Item No.	Service Part No.	Description
1	17243	Cap Screw, 3/8-16 x 2 1/2
2	12013	Locknut, 3/8-16
3	13201	Cap Screw, 3/8-16 x 2 3/4
4	10258	Washer
5	215818	Short Spacer
6	309245	Pivot Screw
7	215815	Pivot Screw
8	309229	Adjusting Screw Assembly
9	10207	Nut
10	14223	Nut, 7/16-20
11	215817	Long Spacer
12	47736	Claw Plate
13	47737	Pivot
14	34607	Base Assembly
-	105273	Parts List

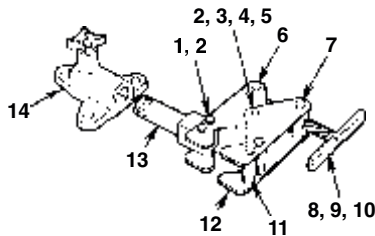

**No. 7539**

**GM F-Body Camber Adjusting Tool**

Item No.	Service Part No.	Description
1	216338	Hook Bolt
2	216337	Turnbuckle
3	309788	Hook

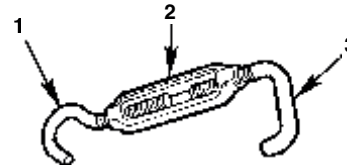

**No. 7577**

**Quick Disconnect Fitting**

Item No.	Service Part No.	Description
1	14513	Hex Head Cap Screw, M6 x 1.0 x 50 mm
2	210192	Warning Decal
3	18996	O-ring
4	47447	Fuel Pressure Test Adapter
5	206877	Coupler Plug
-	105927	Insruction Sheet

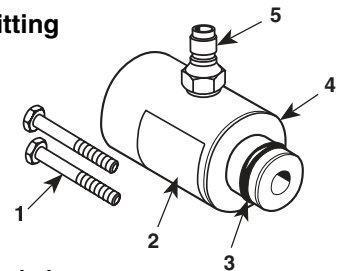

**No. 7532**

**Strut Compressor  
Bridge Accessory**

Item No.	Service Part No.	Description
1	220241	Special Hair Pin
-	105832	Instruction Sheet

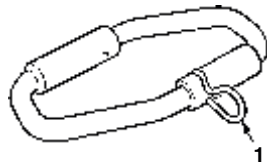

**No. 7588A**  
Ford 4WD Caster /  
Camber Sleeve Puller

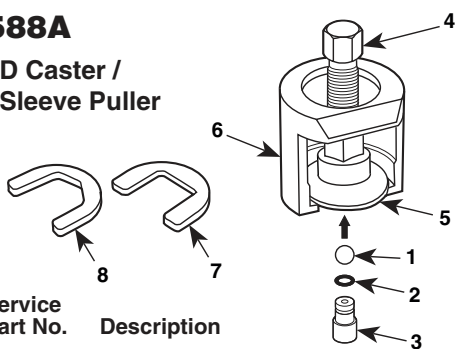

Item No.	Service Part No.	Description
1	10378	Metal Ball
2	10266	O-ring
3	219327	Screw Tip
4	27445	Forcing Screw
5	311573	Swivel Nut
6	311575	Bushing Adapter
7	218990	Horseshoe Clip (.970)
8	221476	Horseshoe Clip (1.110)
-	106014	Parts List

**No. 7598§**  
Conversion Adapter

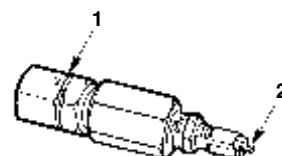

Item No.	Service Part No.	Description
440512 includes the following:		
1	214053	Straight Fitting
2	215806	Shrader Valve Core

**No. 7599§**  
Conversion Adapter

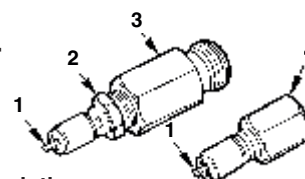

Item No.	Service Part No.	Description
1	215806	Shrader Valve Core
2	206877	Coupler Plug
3	310670	Quick-Disconnect Fitting (includes 206877)
4	212156	Quick-Plug Coupler

**No. 7591**  
Teves / Delco ABS Pressure Fitting



Item No.	Service Part No.	Description
311102 includes the following:		
1	16819	Adapter Fitting
2	48682	Adapter
3	218397	O-ring Packing

**No. 7626**  
TBI Fuel Line Adapter

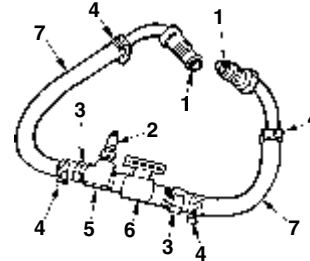

Item No.	Service Part No.	Description
1	18974	O-ring
2	206877	Coupler Plug
3	213721	Carburetor Fuel Fitting
4	210331	Hose Clamp
5	19463	Tee Fitting
6	214114	Plug Valve
7	211473	Pressure Hose

**No. 7597**  
Conversion Adapter Kit

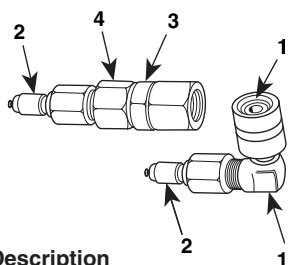

Item No.	Service Part No.	Description
1	215285	90° Elbow Fitting
2	212156	Quick Coupler
3	218214	Straight Fitting
4	210416	Straight Fitting

**No. 7628**  
5/16" Special Fitting Set

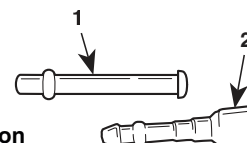

Item No.	Service Part No.	Description
1	216812	Special Fitting
2	216263	Special Fitting

FOR PRICE INFORMATION  
SEE OTC's MASTER PRICE LIST

**No. 7629**

**3/8" Special Fitting Set**

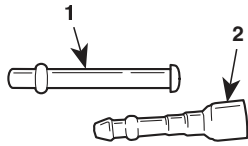

Item No.	Service Part No.	Description
1	216811	Special Fitting
2	216810	Special Fitting

**No. 7632**

**Fuel Return Line Plug**

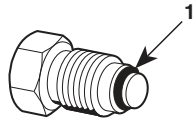

Item No.	Service Part No.	Description
1	11438	Viton O-ring

**No. 7634**

**EFI Pressure Test Adapter**

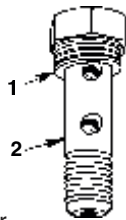

Item No.	Service Part No.	Description
1	215280	Sealing Ring Washer
2	310094	Banjo Bolt, M8 x 1.0

**No. 7638**

**EFI Pressure Test Adapter**

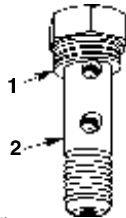

Item No.	Service Part No.	Description
1	215278	Sealing Ring Washer
2	314751	Double Banjo Bolt

**No. 7639**

**GM W-Body Brake Bushing Service Set**

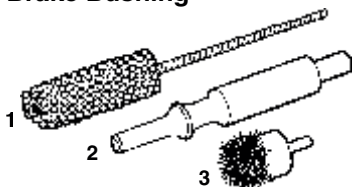

Item No.	Service Part No.	Description
1	219387	Caliper Retaining Bore Hone
2	49012	Brake Caliper Bushing Remover
3	219386	Caliper Bushing Seal Groove Brush

**No. 7640**

**24" Adjustable Wrench**

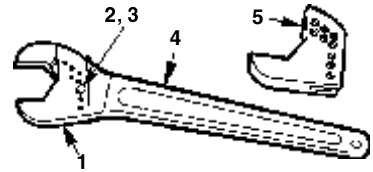

Item No.	Service Part No.	Description
1	48403	Machined Jaw (1 <sup>7</sup> / <sub>16</sub> " to 2 <sup>5</sup> / <sub>16</sub> " adjustment)
2	10388	Hex Jam Nut
3	22953	Cap Screw
4	48395	Handle Assembly
5	48400	Machined Jaw (optional), 1 <sup>3</sup> / <sub>8</sub> " to 2 <sup>7</sup> / <sub>8</sub> " adjustment

**No. 7641**

**36" Adjustable Wrench**

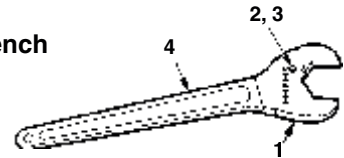

Item No.	Service Part No.	Description
1	48412	Machined Jaw (2 <sup>3</sup> / <sub>4</sub> " to 4 <sup>3</sup> / <sub>4</sub> " adjustment)
2	10388	Hex Jam Nut
3	23518	Cap Screw
4	53642	Handle Assembly

**No. 7644**

**Serpentine Belt Service Tool**

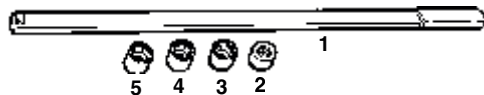

Item No.	Service Part No.	Description
1	218509	Long Handle Wrench
2	311210	13 mm Socket
3	311209	15 mm Socket
4	311208	16 mm Socket
5	311207	18 mm Socket

**No. 7665**

**GM TBI Fuel Line Fitting**

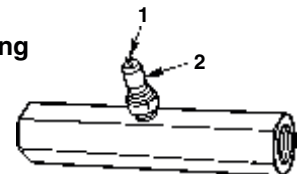

Item No.	Service Part No.	Description
1	215806	Shrader Valve Core
2	218336	Straight Fitting
-	106378	Instruction Sheet



**No. 7676**  
**Alignment Assist Tool**

Item No.	Service Part No.	Description
1	10217	Nut, 3/4-10
2	311792	Screw Bracket
3	311791	Adjusting Screw
-	105811	Parts List

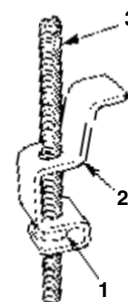

**No. 7667**  
**GM Computer-Controlled Carburetor Tools**

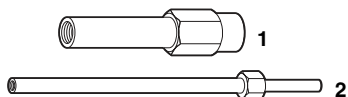

Item No.	Service Part No.	Description
1	220437	7mm / 10mm Double-D Carburetor Tool
2	220436	2mm Double-D / 2.5mm Hex Carburetor Tool

**No. 7677**  
**Exhaust Hanger Pliers**

Item No.	Service Part No.	Description
1	13116	Locknut
2	14564	Handle Grip
3	49073	Drive Plier Handle
4	53856	Support Plier Handle
5	10416	Socket Head Shoulder Screw

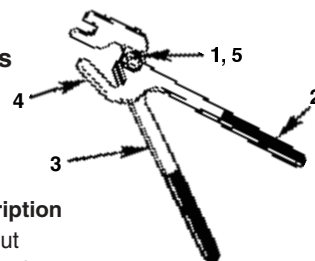

**No. 7670**  
**Gasoline Quality Testing Kit**

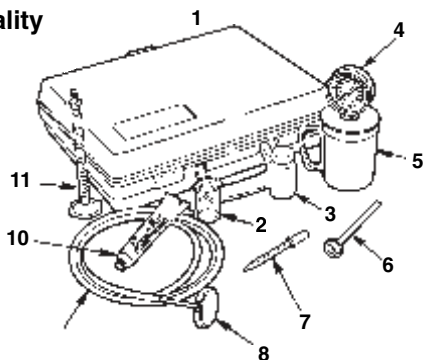

Item No.	Service Part No.	Description
1	14713	Plastic Case
2	218278	Beaker
3	218277	Plastic Bottle
4	311068	Gas Vapor Tester
5	218274	Thermal Mug
6	ROB10569	Thermometer
7	218280	Pipette
8	311073	Flexible Probe
9	218312	Nylon Tubing
10	218275	Water Detection Paste
11	218279	Graduated Cylinder
-	48680	Instruction Decal

**No. 7703**  
**Ten Pound Slide Hammer Puller**

Item No.	Service Part No.	Description
1	312297	10 Lb. Hammer
2	312296	Shank and Tee Bar Assembly
3	10394	Hex Jam Nut

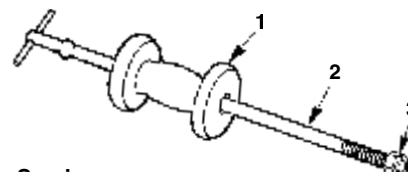

**No. 7704**  
**4WD Ball Joint Service Tools**

Item No.	Service Part No.	Description
1	38355	Installing Cup
2	38354	Receiving Cup
3	204508	Receiving Cup
-	105816	Parts List

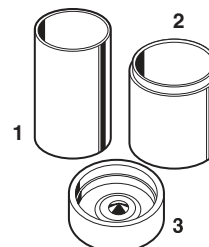

FOR PRICE INFORMATION  
SEE OTC's MASTER PRICE LIST

### No. 7771

#### Ford Power Steering Pump Pulley Installer

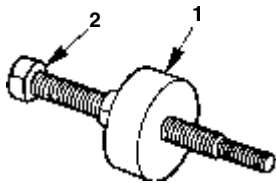

Item No.	Service Part No.	Description
1	312346	Special Nut
2	312347	Forcing Screw

### No. 7790

#### Flange-Type Puller Set

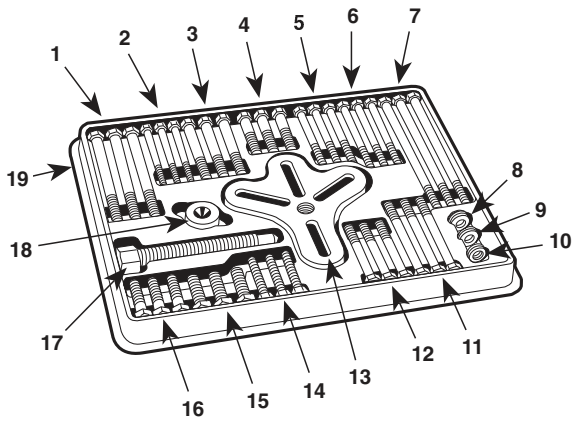

Item No.	Service Part No.	Description
1	12407	Hex Head Cap Screw, 3/8-16 x 4 1/2
2	216795	Hex Head Cap Screw, 1/4-28 x 3
3	10060	Hex Head Cap Screw, 3/8-16 x 3
4	10057	Hex Head Cap Screw, 3/8-16 x 2
5	10042	Hex Head Cap Screw, 5/16-24 x 3
6	10043	Hex Head Cap Screw, 5/16-18 x 3 1/2
7	215349	Hex Head Cap Screw, 5/16-18 x 6
8	10258	Plain Washer, 3/8"
9	10229	Washer, 1/4"
10	10257	Bolt Washer, 5/16"
11	213232	Hex Hd. Cap Screw, M8 x 1.25 x 90mm
12	220113	Hex Hd. Cap Screw, M8 x 1.25 x 65mm
13	512888	Flange Puller
14	214170	Hex Hd. Cap Screw, M8 x 1.25 x 45mm
15	206158	Cap Screw
16	10054	Hex Head Cap Screw, 3/8-24 x 1 1/2
17	24833	Forcing Screw
18	26342	Shaft Protector
19	54327	Plastic Tray

### No. 7791

#### GM Fuel Injection Fitting

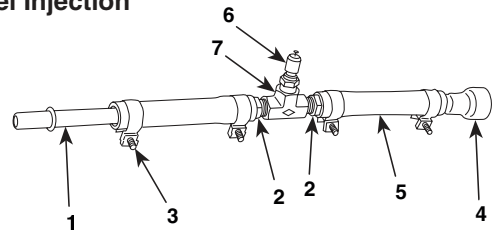

Item No.	Service Part No.	Description
1	216811	Special Fitting
2	213722	Carburetor Fuel Fitting, 3/8"
3	213720	Hose Clamp
4	216810	Special Fitting
5	213719	Hose, 3/8" I.D.
6	206877	Coupler Plug
7	12165	Tee Fitting, 1/8" NPTF
-	106033	Parts List

### No. 7794

#### (205-D036) Pinion & Carrier Bearing Puller

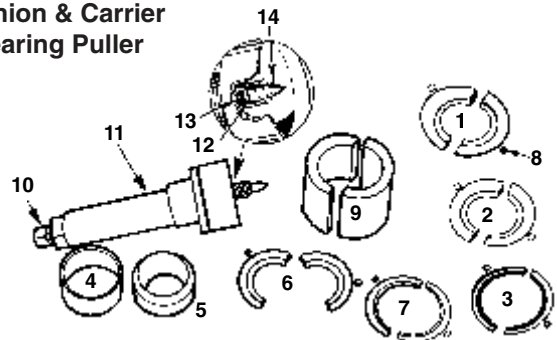

Item No.	Service Part No.	Description
1	44800	Collet Half
2	44802	Collet Half
3	45145	Collet Half
4	303174	Insert
5	303173	Insert
6	44801	Collet Half
7	44803	Collet Half
8	17965	Cap Screw, #8-32 x 1/4" Long
9	44797	Collet Half
10	303171	Screw
11	303167	Tube
12	10268	O-ring
13	12547	Steel Ball, 7/16"
14	303170	Point
-	104656	Parts List



**No. 7799**  
**Fuel Injection Fitting  
Conversion Adapter**

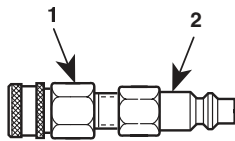

Item No.	Service Part No.	Description
1	212191	Coupler Socket
2	19520	Coupler Plug

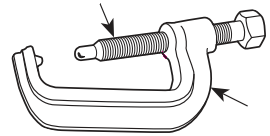

**No. 7809**  
**Saturn Rear Toe Adjustment Tool**

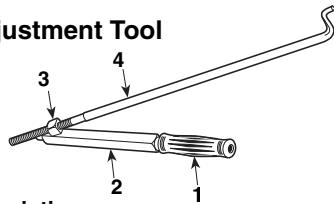

Item No.	Service Part No.	Description
1	11610	Handle Grip
2	310396	Handle
3	24847	Tapped Swivel
4	310397	Rod
-	105948	Instruction Sheet

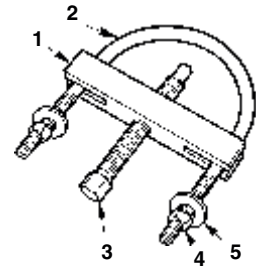

**No. 7815**  
**Steering Wheel Lock  
Plate Remover**

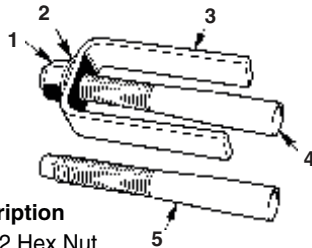

Item No.	Service Part No.	Description
1	10211	9/16-12 Hex Nut
2	14869	S.A.E. Washer
3	313024	Bridge
4	313275	M14 x 1.5 Screw
5	313276	9/16-18 Screw

**No. 7830A**  
**Power Steering Pump Pulley  
Remover / Installer Set**

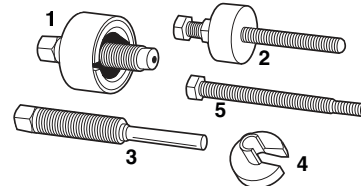

Item No.	Service Part No.	Description
1	7185	Power Steering Pump / Alternator Pulley Remover (see No. 7185 for parts)
2	7209	GM Power Steering Pump Pulley Installer (see No. 7209 for parts)
3	7104	GM Power Steering Pump Pulley Remover Forcing Screw (see No. 7104 for parts)
4	7244	Quick Disconnect Tool
5	312347	Forcing Screw

**No. 7816**  
**Ford Torsion Bar  
Adjustment Tool**

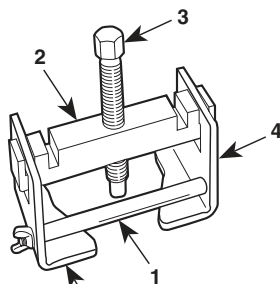

Item No.	Service Part No.	Description
1	202-204	Spacer
2	204-207	Bar
3	204-208	Forcing Screw
4	204-209	Adapter Plate
5	204-210	Adapter Plate
-	105963	Parts List

FOR PRICE INFORMATION  
SEE OTC's MASTER PRICE LIST

### No. 7840

#### GM Caster / Camber Adjusting Wrench

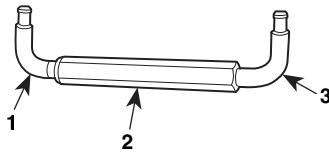

Item No.	Service Part No.	Description
1	313429	Hook, Left Hand Threads
2	313708	Body
3	313428	Hook, Right Hand Threads
-	105984	Instruction Sheet

### No. 7851

#### Banjo Bolt

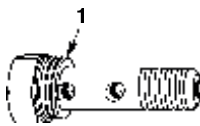

Item No.	Service Part No.	Description
1	221712	Sealing Ring Washer

### No. 7852

#### Quick-Disconnect Fuel Injection Banjo Fitting

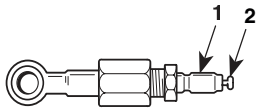

Item No.	Service Part No.	Description
1	440642	Special Fitting
2	215806	Schrader Valve Core

### No. 7853

#### Proportioning Valve Depressor for ABS Brake Systems

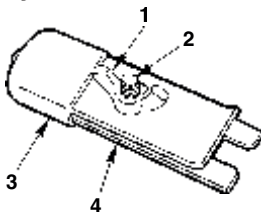

Item No.	Service Part No.	Description
1	13024	1/4-20 Steel Wing Nut
2	RS-2100-6	Carriage Bolt
3	RS-23100-586	Plastisol Grip
4	J-39177-1	Clip

### No. 7874

#### GM TBI Low Pressure Gauge Assembly

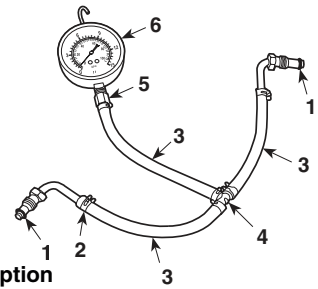

Item No.	Service Part No.	Description
1	18974	Viton O-ring
2	213720	Hose Clamp
3	213719	Pressure Hose
4	221551	Barbed Tee
5	213734	Barbed Hose Fitting
6	440047-1	0-15 PSI Pressure Gauge
-	218165	Warning Decal

### No. 7876

#### GM W-Body Strut Retaining Tool



Item No.	Service Part No.	Description
1	J-38844-1	Strut Retaining Tool
2	J-38844-2	Nut

### No. 7885

#### Fan Clutch Wrenches and Case



Item No.	Service Part No.	Description
1	513900	Case
2	513739	17/16" Fan Clutch Wrench
3	413742	17/16" Fan Clutch Wrench
4	513745	19/16" Fan Clutch Wrench
5	513746	23/8" GM Fan Clutch Wrench
6	513744	17/8" Fan Clutch Nut Wrench
7	513740	213/16" Fan Hub Wrench
8	513738	21/8" Fan Clutch Pulley Wrench
9	513743	31/4" Fan Pulley Holding Wrench
10	513741	21/4" Fan Clutch Pulley Wrench
11	513747	3" Fan Clutch Pulley Holding Wrench

### No. 7886

#### Bendix 10 ABS Fitting

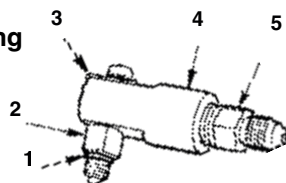

Item No.	Service Part No.	Description
1	218339	O-ring
2	MLR-6491A-1	Adapter
3	MLR-6491A-3	External Cotter Hair Pin
4	MLR-7212A3	Fitting
5	16779	Straight Adapter
-	17716	O-ring
-	106043	Instruction Sheet

### No. 7894

#### Upper / Lower Ball Joint Adapter Set

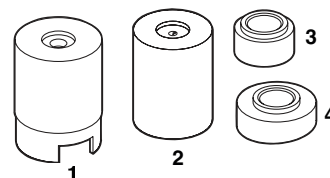

Item No.	Service Part No.	Description
1	313967	Remover Cup
2	313969	Installer Cup
3	313968	Remover
4	313970	Installer
-	106084	Parts List

### No. 7889

#### Pivot Pin Remover

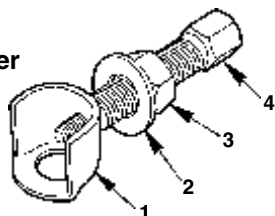

Item No.	Service Part No.	Description
1	J-21854-1	Remover
2	10257	Washer, 5/16"
3	10203	Hex Nut
4	J-21179-5	Screw

### No. 7902

#### Chrysler Fuel Injection Fitting

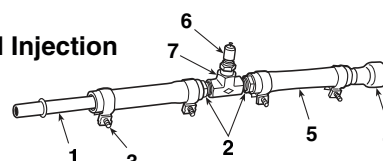

Item No.	Service Part No.	Description
1	216812	Special Fitting
2	213721	5/16" Carburetor Fuel Fitting
3	213720	Hose Clamp
4	218388	Special Fitting
5	211473	Hose, 5/16" I.D.
6	206877	Coupler Plug
7	12165	1/8 NPTF Tee Fitting
-	106105	Parts List

### No. 7890

#### Delco CS Alternator Bearing Remover / Installer Set

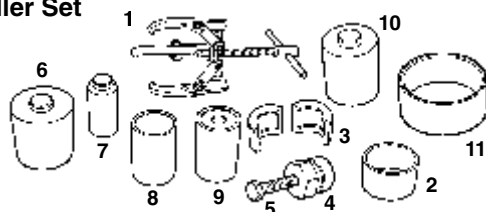

Item No.	Service Part No.	Description
1	1021	3-Jaw Puller (see 1021 for parts)
2	221887	Sleeve
3	221889	Collet Half
4	221888	Special Nut
5	207999	Hex Head Cap Screw
6	221884	Bearing Installer
7	221882	Bearing Remover
8	221886	Bearing Installer
9	221885	Bearing Installer
10	221883	Bearing Installer
11	221881	Tube
-	106066	Parts List

### No. 7911 7912

#### GM Crankshaft Balancer Puller & Adapters

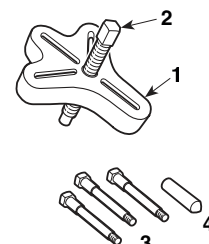

Item No.	Service Part No.	Description
1	512888	Flange Puller (7912)
2	24833	Forcing Screw (7912)
3	222191	Special Screw (1 only, 3 reqd.)
4	222213	Screw Extension

### No. 7913

#### Front Wheel Bearing Locknut Socket

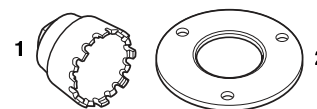

Item No.	Service Part No.	Description
1	J-42119-1	Wrench
2	J-42119-2	Wrench Plate

FOR PRICE INFORMATION  
SEE OTC's MASTER PRICE LIST

### No. 7916

#### Dodge Fuel Injection Adapter

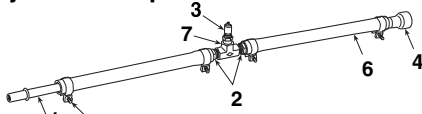

Item No.	Service Part No.	Description
1	314290	Special Fitting
2	213722	Fuel Fitting
3	206877	Coupler Plug
4	216810	Special Fitting
5	213720	Hose Clamp
6	213719	Pressure Hose
7	12165	Tee Fitting
-	106144	Parts List

### No. 7924A

#### Ford Front Hub Installer

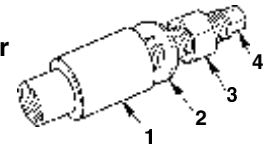

Item No.	Service Part No.	Description
1	207968	Sleeve
2	12330	3/4" Washer
3	12121	3/4-10 Hex Nut
4	314288	22mm x 1.5 Special Screw

### No. 7918

#### Master Ball Joint Adapter Set (includes all parts listed)

### No. 7919

#### Ford Ball Joint Adapter Set

### No. 7920

#### GM Lower Ball Joint Adapter Set

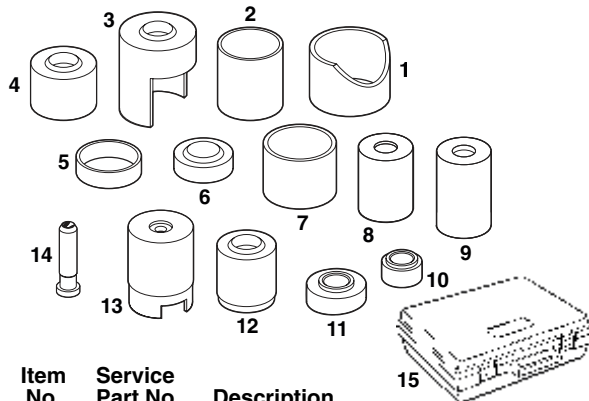

Item No.	Service Part No.	Description
1	222306	Receiving Tube (included in 7920)
2	222305	Receiving Tube (included in 7919)
3	313444	Ball Joint Remover (included in 7919)
4	39976	Receiving Cup (included in 7919)
5	222304	Receiving Tube (included in 7919)
6	204508	Receiving Cup (included in 7919, 7920)
7	222307	Receiving Tube (Included in 7920)
8	313969	Installing Cup
9	38355	Installing Cup
10	313968	Remover (included in 7919)
11	313970	Installer
12	38354	Receiving Cup
13	313967	Remover Cup
14	314392	Live Center Forcing Screw Plug
15	514479	Carrying Case
-	106141	Parts List for 7918
-	106136	Parts List for 7919
-	106137	Parts List for 7920

### No. 7927A

#### Steering Wheel Puller & Lock Plate Remover Set

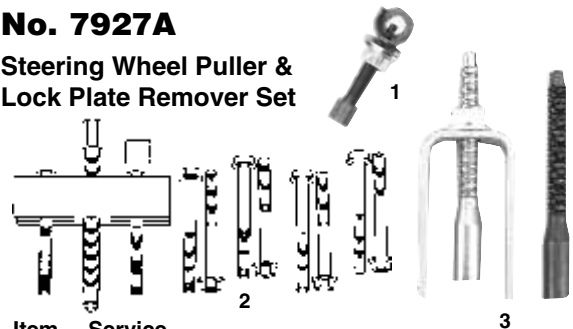

Item No.	Service Part No.	Description
1	7889	Steering Pivot Pin Remover (see No. 7889 for parts)
2	7245	Steering Wheel Puller (see No. 7249 for parts)
3	7815	Steering Wheel Lock Plate Remover (see No. 7815 for parts)

### No. 7942A

#### Hub Resurfacing Pads



Item No.	Service Part No.	Description
1	J-42450-9	Disc Holder
2	222548	Sanding Pads (5 Pack)

### No. 7996

#### Honda Lower Ball Joint Tools

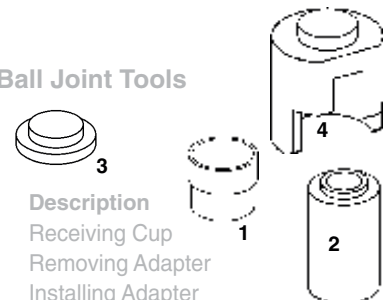

Item No.	Service Part No.	Description
1	314425	Receiving Cup
2	314426	Removing Adapter
3	314428	Installing Adapter
4	314427	Receiving Cup
-	106192	Instruction Sheet

### No. 7998

#### Chrysler Fuel Pump Module Spanner Wrench

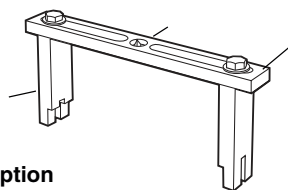

Item No.	Service Part No.	Description
1	11573	Hex Head Cap Screw (2 req.)
2	10257	5/16" Bolt Washer (2 req.)
3	312723	Bar
4	312724	Leg (2 req.)
—	106193	Instruction Sheet

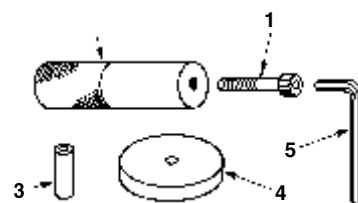

### No. 8031

#### Ball Joint Service Set

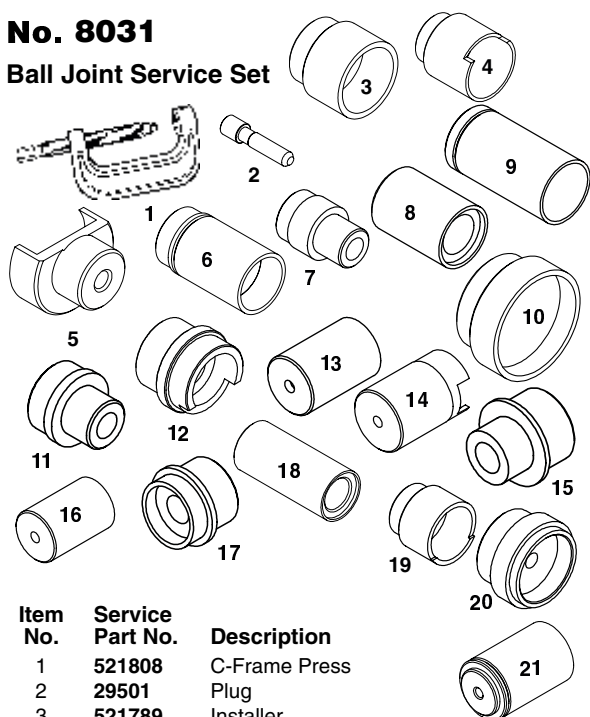

Item No.	Service Part No.	Description
1	521808	C-Frame Press
2	29501	Plug
3	521789	Installer
4	521790	Receiver Cup / Remove
5	521791	Remove / Installer
6	521792	Installer Cup
7	521793	Remove
8	521794	Installer
9	521795	Remove Cup
10	521796	Receiver Cup
11	521797	Remove
12	521798	Receiver
13	521799	Installer
14	521800	Remove / Installer
15	521801	Remove / Installer
16	521802	Remove / Installer
17	521803	Remove / Installer
18	521804	Receiver
19	521805	Receiver
20	521806	Installer
21	521807	Receiver Cup
—	522074	Inside Lid Decal
—	521718	Storage Case
—	517921	Parts List

**FOR PRICE INFORMATION  
SEE OTC's MASTER PRICE LIST**

4	<b>27509</b>	1 <sup>5</sup> / <sub>8</sub> " Dia. Disc
4	<b>27510</b>	1 <sup>11</sup> / <sub>16</sub> " Dia. Disc
4	<b>27511</b>	1 <sup>3</sup> / <sub>4</sub> " Dia. Disc
4	<b>27512</b>	1 <sup>13</sup> / <sub>16</sub> " Dia. Disc
4	<b>27513</b>	1 <sup>7</sup> / <sub>8</sub> " Dia. Disc
4	<b>27514</b>	1 <sup>15</sup> / <sub>16</sub> " Dia. Disc
4	<b>27515</b>	2" Dia. Disc
4	<b>27516</b>	2 <sup>1</sup> / <sub>16</sub> " Dia. Disc
4	<b>27517</b>	2 <sup>1</sup> / <sub>8</sub> " Dia. Disc
4	<b>27518</b>	2 <sup>3</sup> / <sub>16</sub> " Dia. Disc
4	<b>27519</b>	2 <sup>1</sup> / <sub>4</sub> " Dia. Disc
4	<b>27520</b>	2 <sup>5</sup> / <sub>16</sub> " Dia. Disc
4	<b>27521</b>	2 <sup>3</sup> / <sub>8</sub> " Dia. Disc
4	<b>27522</b>	2 <sup>7</sup> / <sub>16</sub> " Dia. Disc
4	<b>27523</b>	2 <sup>1</sup> / <sub>2</sub> " Dia. Disc
4	<b>27524</b>	2 <sup>9</sup> / <sub>16</sub> " Dia. Disc
4	<b>27525</b>	2 <sup>5</sup> / <sub>8</sub> " Dia. Disc
4	<b>27526</b>	2 <sup>11</sup> / <sub>16</sub> " Dia. Disc
4	<b>27527</b>	2 <sup>3</sup> / <sub>4</sub> " Dia. Disc
4	<b>27528</b>	2 <sup>13</sup> / <sub>16</sub> " Dia. Disc
4	<b>27529</b>	2 <sup>7</sup> / <sub>8</sub> " Dia. Disc
4	<b>27530</b>	2 <sup>15</sup> / <sub>16</sub> " Dia. Disc
4	<b>27531</b>	3" Dia. Disc
5	<b>15770-6</b>	Hex Key
-	<b>13676</b>	Instruction Sheet
-	<b>14744</b>	Instruction Decal

**Set 27795**

<b>Item No.</b>	<b>Service Part No.</b>	<b>Description</b>
1	<b>10012</b>	1/4-20 x 7/8" Socket Head Cap Screw
1	<b>10020</b>	1/4-20 x 1 1/4" Socket Head Cap Screw
1	<b>10854</b>	1/4-20 x 1 3/4" Socket Head Cap Screw
1	<b>12001</b>	1/4-20 x 2 1/4" Socket Head Cap Screw
1	<b>10855</b>	1/4-20 x 2 3/4" Socket Head Cap Screw
2	<b>27489</b>	1 5/8" Handle (6" Long)
4	<b>27532</b>	3 1/16" Dia. Disc
4	<b>27533</b>	3 1/8" Dia. Disc
4	<b>27534</b>	3 3/16" Dia. Disc
4	<b>27535</b>	3 1/4" Dia. Disc
4	<b>27536</b>	3 5/16" Dia. Disc
4	<b>27537</b>	3 3/8" Dia. Disc
4	<b>27538</b>	3 7/16" Dia. Disc
4	<b>27539</b>	3 1/2" Dia. Disc
4	<b>27540</b>	3 9/16" Dia. Disc
4	<b>27541</b>	3 5/8" Dia. Disc
4	<b>27542</b>	3 11/16" Dia. Disc
4	<b>27543</b>	3 3/4" Dia. Disc
4	<b>27544</b>	3 13/16" Dia. Disc
4	<b>27545</b>	3 7/8" Dia. Disc
4	<b>27546</b>	3 15/16" Dia. Disc
4	<b>27547</b>	4" Dia. Disc
4	<b>27548</b>	4 1/16" Dia. Disc
4	<b>27549</b>	4 1/8" Dia. Disc
4	<b>27550</b>	4 3/16" Dia. Disc
4	<b>27551</b>	4 1/4" Dia. Disc
4	<b>27552</b>	4 5/16" Dia. Disc
4	<b>27553</b>	4 3/8" Dia. Disc
4	<b>27554</b>	4 7/16" Dia. Disc
4	<b>27555</b>	4 1/2" Dia. Disc
5	<b>15770-6</b>	Hex Key
-	<b>13676</b>	Instruction Sheet
-	<b>14744</b>	Instruction Decal

**Set 27796**

<b>Item No.</b>	<b>Service Part No.</b>	<b>Description</b>
1	<b>10012</b>	1/4-20 x 7/8" Socket Head Cap Screw
1	<b>10020</b>	1/4-20 x 1 1/4" Socket Head Cap Screw
1	<b>10854</b>	1/4-20 x 1 3/4" Socket Head Cap Screw
1	<b>12001</b>	1/4-20 x 2 1/4" Socket Head Cap Screw
1	<b>10855</b>	1/4-20 x 2 3/4" Socket Head Cap Screw
2	<b>27488</b>	1 1/4" Handle
4	<b>27515</b>	2" Dia. Disc
4	<b>27516</b>	2 1/16" Dia. Disc
4	<b>27517</b>	2 1/8" Dia. Disc
4	<b>27518</b>	2 3/16" Dia. Disc
4	<b>27519</b>	2 1/4" Dia. Disc
4	<b>27520</b>	2 5/16" Dia. Disc
4	<b>27521</b>	2 3/8" Dia. Disc
4	<b>27522</b>	2 7/16" Dia. Disc
4	<b>27523</b>	2 1/2" Dia. Disc
4	<b>27524</b>	2 9/16" Dia. Disc
4	<b>27525</b>	2 5/8" Dia. Disc
4	<b>27526</b>	2 11/16" Dia. Disc
4	<b>27527</b>	2 3/4" Dia. Disc
4	<b>27528</b>	2 13/16" Dia. Disc
4	<b>27529</b>	2 7/8" Dia. Disc
4	<b>27530</b>	2 15/16" Dia. Disc
4	<b>27531</b>	3" Dia. Disc
4	<b>27532</b>	3 1/16" Dia. Disc
4	<b>27533</b>	3 1/8" Dia. Disc
4	<b>27534</b>	3 3/16" Dia. Disc
4	<b>27535</b>	3 1/4" Dia. Disc
4	<b>27536</b>	3 5/16" Dia. Disc
4	<b>27537</b>	3 3/8" Dia. Disc
4	<b>27538</b>	3 7/16" Dia. Disc
4	<b>27539</b>	3 1/2" Dia. Disc
5	<b>15770-6</b>	Hex Key
-	<b>13676</b>	Instruction Sheet
-	<b>14744</b>	Instruction Decal

**Master Set 27797**

<b>Item No.</b>	<b>Service Part No.</b>	<b>Description</b>
1	<b>10012</b>	1/4-20 x 7/8" Socket Head Cap Screw
1	<b>10020</b>	1/4-20 x 1 1/4" Socket Head Cap Screw
1	<b>10854</b>	1/4-20 x 1 3/4" Socket Head Cap Screw
1	<b>12001</b>	1/4-20 x 2 1/4" Socket Head Cap Screw
1	<b>10855</b>	1/4-20 x 2 3/4" Socket Head Cap Screw
2	<b>27487</b>	3/4" Handle
2	<b>27488</b>	1 1/4" Handle
2	<b>27489</b>	1 5/8" Handle
3	<b>27490</b>	Extension Tube
4	<b>27491</b>	1/2" Dia. Disc
4	<b>27492</b>	9/16" Dia. Disc
4	<b>27493</b>	5/8" Dia. Disc
4	<b>27494</b>	1 1/16" Dia. Disc
4	<b>27495</b>	3/4" Dia. Disc
4	<b>27496</b>	1 3/16" Dia. Disc
4	<b>27497</b>	7/8" Dia. Disc
4	<b>27498</b>	1 5/16" Dia. Disc
4	<b>27499</b>	1" Dia. Disc

4	<b>27500</b>	1 <sup>1</sup> / <sub>16</sub> " Dia. Disc
4	<b>27501</b>	1 <sup>1</sup> / <sub>8</sub> " Dia. Disc
4	<b>27502</b>	1 <sup>3</sup> / <sub>16</sub> " Dia. Disc
4	<b>27503</b>	1 <sup>1</sup> / <sub>4</sub> " Dia. Disc
4	<b>27504</b>	1 <sup>5</sup> / <sub>16</sub> " Dia. Disc
4	<b>27505</b>	1 <sup>3</sup> / <sub>8</sub> " Dia. Disc
4	<b>27506</b>	1 <sup>7</sup> / <sub>16</sub> " Dia. Disc
4	<b>27507</b>	1 <sup>1</sup> / <sub>2</sub> " Dia. Disc
4	<b>27508</b>	1 <sup>9</sup> / <sub>16</sub> " Dia. Disc
4	<b>27509</b>	1 <sup>5</sup> / <sub>8</sub> " Dia. Disc
4	<b>27510</b>	1 <sup>11</sup> / <sub>16</sub> " Dia. Disc
4	<b>27511</b>	1 <sup>3</sup> / <sub>4</sub> " Dia. Disc
4	<b>27512</b>	1 <sup>13</sup> / <sub>16</sub> " Dia. Disc
4	<b>27513</b>	1 <sup>7</sup> / <sub>8</sub> " Dia. Disc
4	<b>27514</b>	1 <sup>15</sup> / <sub>16</sub> " Dia. Disc
4	<b>27515</b>	2" Dia. Disc
4	<b>27516</b>	2 <sup>1</sup> / <sub>16</sub> " Dia. Disc
4	<b>27517</b>	2 <sup>1</sup> / <sub>8</sub> " Dia. Disc
4	<b>27518</b>	2 <sup>3</sup> / <sub>16</sub> " Dia. Disc
4	<b>27519</b>	2 <sup>1</sup> / <sub>4</sub> " Dia. Disc
4	<b>27520</b>	2 <sup>5</sup> / <sub>16</sub> " Dia. Disc
4	<b>27521</b>	2 <sup>3</sup> / <sub>8</sub> " Dia. Disc
4	<b>27522</b>	2 <sup>7</sup> / <sub>16</sub> " Dia. Disc
4	<b>27523</b>	2 <sup>1</sup> / <sub>2</sub> " Dia. Disc
4	<b>27524</b>	2 <sup>9</sup> / <sub>16</sub> " Dia. Disc
4	<b>27525</b>	2 <sup>5</sup> / <sub>8</sub> " Dia. Disc
4	<b>27526</b>	2 <sup>11</sup> / <sub>16</sub> " Dia. Disc
4	<b>27527</b>	2 <sup>3</sup> / <sub>4</sub> " Dia. Disc
4	<b>27528</b>	2 <sup>13</sup> / <sub>16</sub> " Dia. Disc
4	<b>27529</b>	2 <sup>7</sup> / <sub>8</sub> " Dia. Disc
4	<b>27530</b>	2 <sup>15</sup> / <sub>16</sub> " Dia. Disc
4	<b>27531</b>	3" Dia. Disc
4	<b>27532</b>	3 <sup>1</sup> / <sub>16</sub> " Dia. Disc
4	<b>27533</b>	3 <sup>1</sup> / <sub>8</sub> " Dia. Disc
4	<b>27534</b>	3 <sup>3</sup> / <sub>16</sub> " Dia. Disc
4	<b>27535</b>	3 <sup>1</sup> / <sub>4</sub> " Dia. Disc
4	<b>27536</b>	3 <sup>5</sup> / <sub>16</sub> " Dia. Disc
4	<b>27537</b>	3 <sup>3</sup> / <sub>8</sub> " Dia. Disc
4	<b>27538</b>	3 <sup>7</sup> / <sub>16</sub> " Dia. Disc
4	<b>27539</b>	3 <sup>1</sup> / <sub>2</sub> " Dia. Disc
4	<b>27540</b>	3 <sup>9</sup> / <sub>16</sub> " Dia. Disc
4	<b>27541</b>	3 <sup>5</sup> / <sub>8</sub> " Dia. Disc
4	<b>27542</b>	3 <sup>11</sup> / <sub>16</sub> " Dia. Disc
4	<b>27543</b>	3 <sup>3</sup> / <sub>4</sub> " Dia. Disc
4	<b>27544</b>	3 <sup>13</sup> / <sub>16</sub> " Dia. Disc
4	<b>27545</b>	3 <sup>7</sup> / <sub>8</sub> " Dia. Disc
4	<b>27546</b>	3 <sup>15</sup> / <sub>16</sub> " Dia. Disc
4	<b>27547</b>	4" Dia. Disc
4	<b>27548</b>	4 <sup>1</sup> / <sub>16</sub> " Dia. Disc
4	<b>27549</b>	4 <sup>1</sup> / <sub>8</sub> " Dia. Disc
4	<b>27550</b>	4 <sup>3</sup> / <sub>16</sub> " Dia. Disc
4	<b>27551</b>	4 <sup>1</sup> / <sub>4</sub> " Dia. Disc
4	<b>27552</b>	4 <sup>5</sup> / <sub>16</sub> " Dia. Disc
4	<b>27553</b>	4 <sup>3</sup> / <sub>8</sub> " Dia. Disc
4	<b>27554</b>	4 <sup>7</sup> / <sub>16</sub> " Dia. Disc
4	<b>27555</b>	4 <sup>1</sup> / <sub>2</sub> " Dia. Disc
5	<b>15770-6</b>	Hex Key
-	<b>13676</b>	Instruction Sheet
-	<b>14744</b>	Instruction Decal

**No. 42615**  
**Drum Leveling Assembly**

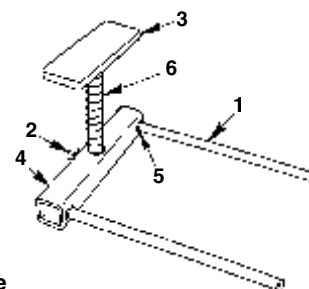

Item No.	Service Part No.	Description
1	<b>37153</b>	Shaft
2	<b>17010</b>	Thumb Screw
3	<b>37157</b>	Leveler Pad
4	<b>42614</b>	Tube
5	<b>11581</b>	Retaining Ring
6	<b>17015</b>	Compression Spring

**No. 205776**  
**Fuller® Bearing Puller Set**

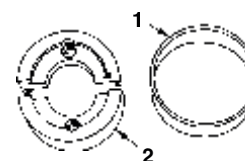

Item No.	Service Part No.	Description
1	<b>39546</b>	Sleeve
2	<b>43868</b>	Collet Half

**No. 208675**  
**Swivel Assembly**

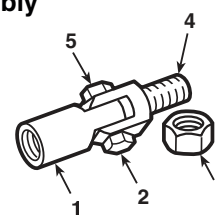

Item No.	Service Part No.	Description
1	<b>33538</b>	Swivel Adapter
2	<b>27912</b>	Cap Screw
3	<b>12121</b>	<sup>3</sup> / <sub>4</sub> -10 Hex Nut
4	<b>27914</b>	Swivel
5	<b>10390</b>	Hex Jam Nut

FOR PRICE INFORMATION  
SEE OTC's MASTER PRICE LIST

### No. 302340

#### Yoke Assembly

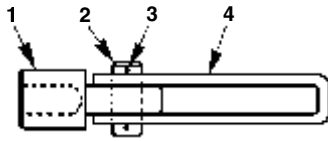

Item No.	Service Part No.	Description
1	33768	Adapter
2	205771	Hinge Pin
3	10573	Cotter Pin
4	208674	Yoke Sleeve

### No. J-22517-C

#### GM Torsion Bar Unloader

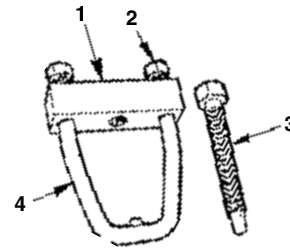

Item No.	Service Part No.	Description
1	J-22517-8	Plate
2	10213	Hex Nut
3	J-22517-3	Pressing Screw
4	J-22517-7	"U" Bolt

### No. 305811

#### AdjustaGrip® Mounting Arm

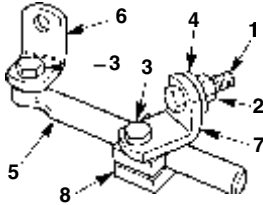

Item No.	Service Part No.	Description
1	10085	Hex Head Cap Screw
2	10208	Hex Nut
3	11622	Hex Head Cap Screw
4	11640	Washer
5	23032	Adjusting Arm
6	23037	Angle Bracket
7	211527	Bracket
8	305809	Block
-	11618	Instruction Tag

### No. 309277

#### Diesel Injector Nozzle Test Adapter

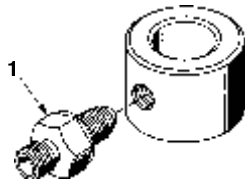

Item No.	Service Part No.	Description
1	38279	Straight Adapter
-	102583	Instruction Sheet



# OLD / NEW PART NUMBER CROSS REFERENCE LIST

Old No.	New No.	Old No.	New No.	Old No.	New No.	Old No.	New No.
515	7392	927-D	1103	943-C-1	32139	959-1	37016
515-1	26603	927-D-1	25936	943-D-16	38662	960	1176
515-5	26342	930-B	1104	943-E	1154	960-1	34698
515-A	7393	930-B-1	32135	943-R	1155	960-2	27241
515-S	24832	930-C	1105	943-S	1156	960-3	24544
515-T	24833	930-C-1	32964	943-S1	208627	960-4	24545
518-1	32843	930-D	1106	943-S3	22185	960-B	1177
518-5	26342	930-D-1	32126	943-S4	34331	970	1200
522-1	22186	930-E	1107	943-S12	208627	970-A	37592
522-2	34703	930-E-1	32132	943-T	1157	970-C-1	27914
679-1	26763	930-F	1108	943-U	1158	970-D-3	27908
679-2	26762	930-F-1	32968	947	1165	970-H-1	12121
680-1	31385	938-1	32127	947-1	33083	970-HY	1202
827-1	32937	938-2	24822	947-2	33084	970-J-1	27912
827-2	32939	938-3	19528	947-3	33001	973	1203
827-3	32940	938-4	24824	947-4	27051	973-2	33769
827-A	32942	938-5	24825	947-5	27052	973-3	33768
827-B	7394	938-6	24826	947-10	33578	973-4	208674
887-1	51033	938-7	24827	947-E	1166	973-5A	205771
887-A	13905	938-HY	1062	949-1/2	1121	973-6	41291
887-D	7400	939-1/2-HY	1076	949-1/2-1	26654	973-8	302482
888	7401	939-1/2-1-B	50503	950	1122	973-11	33538
888-1	33118	939-1/2-5	33785	950-1	26651	973-R	302340
888-A	11608	939-1/2-5-B	28163	950-3	24831	973-S	208675
896-A	8090	939-1/2-A	1112	951	1123	974	1204
896-B	8091	939-1/2-A-1	33004	951-1	32957	974-A	1205
896-C	8092	939-1/2-B	1113	952	1124	1000	1020
896-E	8093	939-1/2-B-1	33005	952-1	32951	1000-1/2-L	1022
896-F	8094	939-1	33038	952-A	1130	1000-1/2-L-1	43661
896-G	8095	939-1-B	33039	952-D	1126	1000-1/2-L-2	27476
896-H	8096	939-2	303961	952-D-1	33486	1000-1/2-L-3	22006
896-J	8097	939-3	208586	953	1127	1000-1/2-L-4	22007
896-K	8098	939-4	208587	953-1	32959	1000-1/2-L-5	22008
897-1	206803	939-5	28353	953-C	1128	1000-1	21908
897-2A	52518	939-7	28390	953-C-1	50855	1000-2	27592
897-4A	25509	939-A	1109	953-C-5	30944	1000-3	207029
897-8	25510	939-A-1	32992	953-D	1129	1000-4	27764
897-A	7402	939-B	1110	953-D-1	32961	1000-5	21917
915-1	208170	939-B-1	32991	953-D-4	23330	1001	1024
915-2	304828	939-C	1111	953-D-5	31037	1001-1	44591
915-A	7403	939-C-1	32998	954	1170	1001-1-B	22023
927-1	33483	943	1150	954-2	27044	1001-4	22025
927-2	24835	943-2	33482	954-8	28382	1001-5	22021
927-3	24836	943-3	24846	954-10	28381	1001-7	39959
927-4	24837	943-4	24847	954-B	1171	1001-B	33397
927-5	24838	943-5	24848	954-C	1172	1001-C	1028
927-6	24839	943-10	24850	955-2	27044	1001-D	1031
927-A	1100	943-15	24864	955-13	29185	1001-L	1025
927-A-1	24840	943-A	1151	955-14	29187	1001-L-1	43940
927-B	1101	943-A-1	32136	956-2	27044	1002	1035
927-B-1	25934	943-B	1152	956-A-13	29189	1002-1	44082
927-C	1102	943-B-1	32137	957	1173	1002-4	22018
927-C-1	25935	943-C	1153	959	1174	1002-5	22016

§ Discontinued. Some service parts may be available.

# OLD / NEW PART NUMBER CROSS REFERENCE LIST

Old No.	New No.	Old No.	New No.	Old No.	New No.	Old No.	New No.
1002-7	27759	1013-1/2-L	1046	CW36	7401	Y-399-1A	43103
1002-8	33398	1013-1/2-LY	1066	GPP14L	7392	Y-399-2A	43104
1002-L	1036	1013-A	1041	GPP14S	7393	Y-399-3	34195
1002-L-1	43892	1013-A-7	41195	GPP27	522	Y-399-4	34193
1003	1039	1013-A-L	1042	HC-642	7310	Y-399-5	28709
1003-1/2	1043	1014	1049	HC-642-1	208910	Y-399-7	28714
1003-1/2-1	30945	1014-7	41198	HC-642-2	39131	Y-399-8	34202
1003-1/2-2-H	41224	1014-L	1050	HC-642-3	26619	Y-399-9	34201
1003-1/2-4	22034	1015-2-H	50462	HC-642-4	205863	Y-399-10	34200
1003-1/2-5	22035	1015-LY	1074	HC-642-A	205862	Y-399-11	34199
1003-1/2-7	33292	1016-2-H	50460	HC-643	7311	Y-399-12	29424
1003-1/2-8	33290	1016-LY	1080	MD-955	7318	Y-399-A	4240
1003-1/2-L	1044	4692-3	34703	MD-956	7319	Y-695-3	22205
1003-1/2-L-1	30949	7025	7248	MD-956-B1	35033		
1003-1/2-LY	1064	7025-A	7249	MD-956-B2	200063		
1003-1	43906	7081	7248	OA-36-3	23518		
1003-4	22028	19690	209950	PH172J	1064		
1003-5	22029	19691	209951	PH173J	1066		
1003-7	33295	19692	209952	PH302J	1072		
1003-8	33399	23034	305809	PH303J	1074		
1003-L	1040	23035	305809	PH503J	1080		
1003-L-1	30902	23380	211527	PM12	1020		
1004	1047	26497	209802	PM13	1021		
1004-1	40303	AP1	1121	PM22	1022		
1004-4	30966	AP2	1122	PM23C	1023		
1004-5	22045	AP4	1123	PM52	1024		
1004-7	33433	AP5	1124	PM52L	1025		
1004-8	33432	AP6	679	PM53C	1026		
1004-L	1048	AP8	1126	PM53CL	1027		
1004-L-1	40305	AP9	1130	PM72	1035		
1005-2-H	41226	AP10	680	PM72L	1036		
1005-4	30976	AP12	1128	PM73C	1037		
1005-5	22052	AP13	1127	PM73CL	1038		
1005-6	22053	AP16	1129	PM132	1039		
1005-L-1	40312	APH6	1154	PM132L	1040		
1005-LY	1072	APH9	1166	PM133C	1041		
1006-4	30993	APP5	1153	PM133CL	1042		
1006-5	22089	APP6	1150	PM172	1043		
1006-L-1	30994	APP7	1151	PM172L	1044		
1010	1021	APP9	1165	PM173	1045		
1010-1/2-A-2	33423	BPS10	981	PM173L	1046		
1010-1/2-LA	1023	CT-684	7307	PM252	1047		
1010-2	27475	CT-685	7308	PM252L	1048		
1011-1	43940	CT-685-1	38012	PM253	1049		
1011-A	1026	CT-685-2	44502	PM253L	1050		
1011-A-7	39942	CT-685-3	41617	PP10	927		
1011-A-L	1027	CT-685-4A	200017	PP17	938		
1012-A	1037	CT-685-4B	200018	PP30	939		
1012-A-7	44993	CT-685-4C	200019	PPH17J	1062		
1012-A-L	1038	CT-686	7309	PPH50J	1076		
1013-1/2	1045	CT-686-1	37813	SS-8	1179		
1013-1/2-2-H	41224	CT-686-2	208602	TC424	7402		
1013-1/2-7	41196	CW14	7400	Y-399	4241		